

Cisco UCS 6400 Series Fabric Interconnects

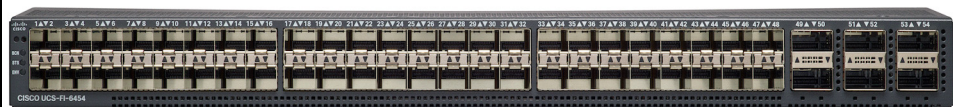

CISCO UCS 6454 FABRIC INTERCONNECT



CISCO UCS 64108 FABRIC INTERCONNECT

CONTENTS

Overview	1
Cisco UCS 6454 54-Port Fabric Interconnect	2
Detailed Front View	3
Front LED Indicators	5
Power Supply LEDs	5
Management Port LEDs	6
Beacon and System Status LEDs	6
L1/L2 Port LEDs	6
Detailed Rear View	7
Rear LED Indicators	8
System Environment LED	8
Ethernet Port (ports 1–48) LEDs	8
40/100 Gbps Port (ports 49–54) LEDs	9
Cisco UCS 64108 108-Port Fabric Interconnect	10
Detailed Front View	11
Front LED Indicators	13
Power Supply LEDs	13
Management Port LEDs	14
Beacon and System Status LEDs	14
L1/L2 Port LEDs	14
Detailed Rear View	15
Rear LED Indicators	16
System Environment LED	16
Ethernet Port (ports 1–96) LEDs	16
40/100 Gbps Port (ports 97–108) LEDs	17
Cisco UCS 6400 Series Fabric Interconnect Capabilities And Features	18
CONFIGURING the FABRIC INTERCONNECTS	20
STEP 1 VERIFY FABRIC INTERCONNECT SKU	21
STEP 2 CHOOSE PORT LICENSES (OPTIONAL)	23
STEP 3 CHOOSE TRANSCEIVERS (OPTIONAL)	25
STEP 4 CHOOSE POWER SUPPLIES	30
6454 FI Fan Module	33
64108 FI Fan Module	33
STEP 5 SELECT AC POWER CORDS	34
STEP 6 ACCESSORY KIT (INCLUDED)	37
STEP 7 CHOOSE SERVICE AND SUPPORT LEVEL	38
SUPPLEMENTAL MATERIAL	47
Cisco UCS 6454 Port Numbering	47
Cisco UCS 64108 Port Numbering	48
Cisco UCS 6454 Supported Speeds	49
Cisco UCS 64108 Supported Speeds	49
Connectivity	50
9508 Chassis Server Connectivity	50
5108 Blade Chassis Server Connectivity	51
C-Series Rack-Mounted Server Connectivity	52
Blade Chassis Connection Types	54
TECHNICAL SPECIFICATIONS	55
Physical and Environmental Specifications	55
Power Supply Specifications	56

CONTENTS

Transceiver Specifications58



Overview

The Cisco UCS 6454 and 64108 Fabric Interconnects are a core part of the Cisco Unified Computing System, providing both network connectivity and management capabilities for the system. The Cisco UCS 6454 and 64108 offer line-rate, low-latency, lossless 10/25/40/50/100 Gigabit Ethernet, Fibre Channel over Ethernet (FCoE), and Fibre Channel functions.

These Cisco Fabric Interconnects provide the management and communication backbone for the Cisco UCS B-Series Blade Servers, UCS 5108 B-series server chassis, UCS Managed C-Series rack servers, and UCS S-Series storage servers. All servers attached to the Cisco UCS 6454 and 64108 Fabric Interconnects become part of a single, highly available management domain. In addition, by supporting unified fabric, the Cisco Fabric Interconnects provide both the LAN and SAN connectivity for all servers within its domain.

From a networking perspective, the Cisco UCS 6454 and 64108 use a cut-through architecture, supporting deterministic, low-latency, line-rate 10/25/40/50/100 Gigabit Ethernet ports, switching capacity of 3.82 Tbps for the 6454, 7.42 Tbps for the 64108, and 200 Gbps bandwidth between the FI 6454 or 64108 and the IOM or 2408 Fabric Extender per 5108 blade chassis, independent of packet size and enabled services. The product family supports Cisco® low-latency, lossless 10/25/40/50/100 Gigabit Ethernet unified network fabric capabilities, which increase the reliability, efficiency, and scalability of Ethernet networks. The Fabric Interconnect supports multiple traffic classes over a lossless Ethernet fabric from the server through the Fabric Interconnect. Significant TCO savings come from an FCoE optimized server design in which network interface cards (NICs), host bus adapters (HBAs), cables, and switches can be consolidated.

There are two options available under the 6400 Series FI

- [Cisco UCS 6454 54-Port Fabric Interconnect on page 2](#)
- [Cisco UCS 64108 108-Port Fabric Interconnect on page 10](#)



NOTE: From 4.1(3) release, FI 6454 and 64108 supports server-ports on the 40/100G ports after break-out (ports 49-54 and 97-108 respectively). Only direct-connect rack-servers at 10/25G speeds with VIC 1455/1457/15428 are supported on the 40/100G ports. Note that server port at 40/100G speeds are not supported. FI 6454 can support maximum of 64 server-ports and FI 64108 can support 128 server ports after breakout of 40/100G ports.

Cisco UCS 6454 54-Port Fabric Interconnect

The Cisco UCS 6454 Fabric Interconnect (FI) is a 1-RU top-of-rack switch that mounts in a standard 19-inch rack such as the Cisco R Series rack. The 6454 is a 10/25/40/100 Gigabit Ethernet, FCoE and Fiber Channel switch offering up to 3.82 Tbps throughput and up to 54 ports. The switch has 16 unified ports (port numbers 1-16) that can support 10/25-Gbps SFP28 Ethernet ports or 8/16/32-Gbps Fibre Channel ports, 28 10/25-Gbps Ethernet SFP28 ports (port numbers 17-44), 4 1/10/25-Gbps Ethernet SFP28 ports (port numbers 45-48), and 6 40/100-Gbps Ethernet QSFP28 uplink ports (port numbers 49-54). All Ethernet ports are capable of supporting FCoE.

The Cisco UCS 6454 Fabric Interconnect also has one network management port, one console port for setting the initial configuration, and one USB port for saving or loading configurations. The FI also includes L1/L2 ports for connecting two fabric interconnects for high availability.

The 54-port chassis is shown in [Figure 1](#).

Figure 1 Cisco UCS Fabric Interconnect 6454 (1RU)

Front View



Rear View

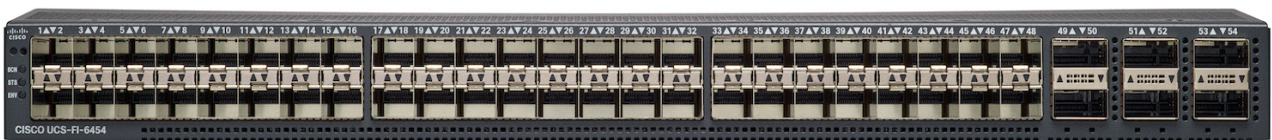

Detailed Front View

The Cisco UCS 6454 front view shown in [Figure 2](#).

Figure 2 Front View of 6454

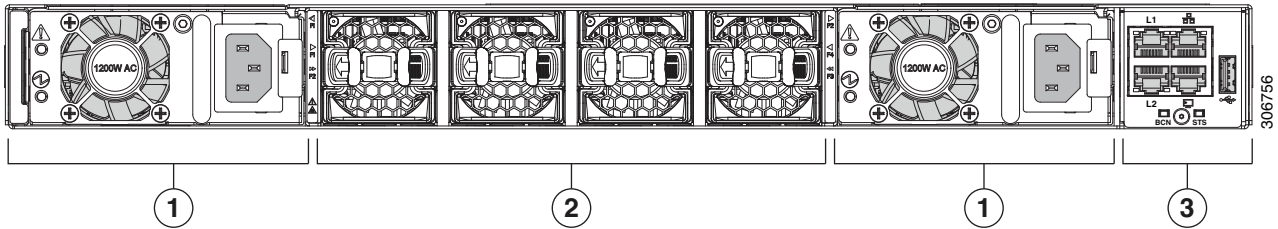

1	Power supplies (two) 650W AC or 930W DC or 1200W HVDC (hot swappable)	3	RJ45 and USB ports (see Figure 3)
2	Fan modules (four), 3+1 redundant (hot swappable)	—	—

Figure 3 RJ45 Connectors and USB Port

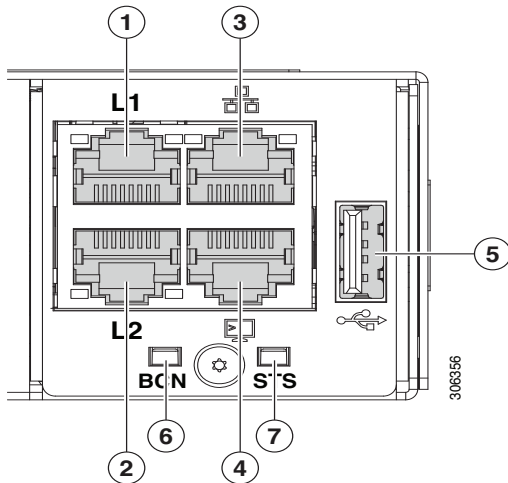

1	L1 High Availability Port	2	L2 High Availability Port
3	RJ45 Network Management Port	4	RJ45 Console Port
5	USB Port	6	Beacon LED
7	System Status LED	—	—

Figure 4 AC Power Supply for the Cisco UCS 6454 Fabric Interconnect

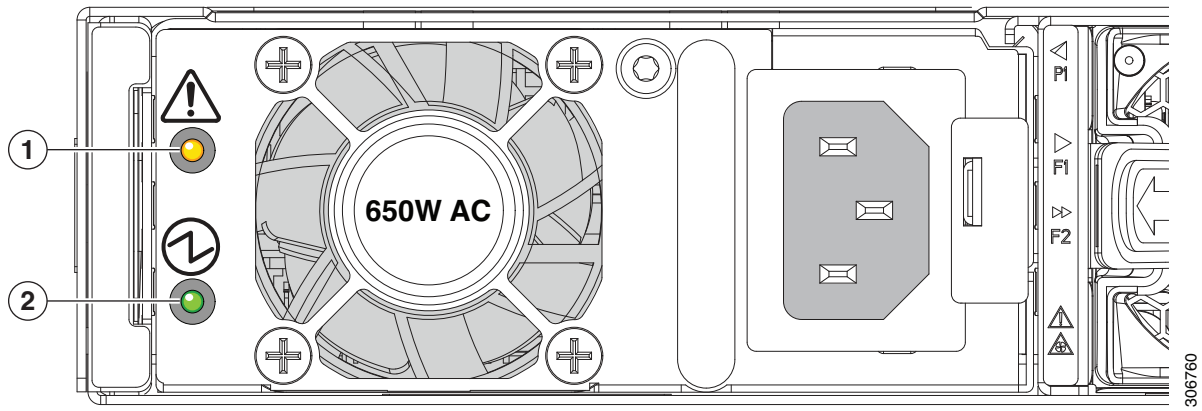

1	Amber fault/error LED	2	Green power on LED
---	-----------------------	---	--------------------

Front LED Indicators

The front LED indicators are described in the following sections

Power Supply LEDs

The power supply LEDs are located on the left front portion of the power supply (see [Figure 4 on page 4](#)). Combinations of states indicated by the Power On (🟢) and Error (⚠️) LEDs indicate the status for the module as shown in [Table 1](#)

Table 1 Power Supply LED States

Power on LED	Error LED	Status
Green	Off	Power supply is on and outputting power to the switch.
Flashing green	Off	Power supply is connected to a power source but not outputting power to the switch—power supply might not be installed in the chassis.
Off	Off	Power supply is not receiving power.
Green	Flashing amber	Power supply warning—possibly one of the following conditions: <ul style="list-style-type: none"> ■ High voltage ■ High power ■ Low voltage ■ Power supply installed in chassis but not connected to a power source ■ Slow power supply fan
Flashing green	Amber	Power supply failure—possibly one of the following conditions: <ul style="list-style-type: none"> ■ Over voltage ■ Over current ■ Over temperature ■ Power supply fan failure

Management Port LEDs

The management port LED states (see [Figure 3 on page 3](#)) are shown in [Table 2](#).

Table 2 Management Port LED States

LED Position	LED State	Description
Left	Off	No link
	Solid green	Physical link
Right	Off	No activity
	Blinking green	Activity

Beacon and System Status LEDs

The beacon and system status LED states (see [Figure 3 on page 3](#)) are shown in [Table 3](#).

Table 3 Beacon and System Status LED States

LED	Location	Function	Color	State	Description
Beacon LED	Front and rear	Identify selected chassis	Blue	Solid on	Chassis is selected
				Off	Chassis is not selected
System status LED	Front and rear	System power/health during boot up and run time	Green	Solid on	Normal operation
				Off	System is powered off
			Amber	On	System fault
			Red	Solid on	Power shut down by software
Blinking	Secure boot validation has failed				

L1/L2 Port LEDs

The L1/L2 port LED states (see [Figure 3 on page 3](#)) are shown in [Table 4](#).

Table 4 L1/L2 Port LED States

LED Position	LED State	Description
Left	Off	No link
	Solid green	Physical link
Right	Off	No activity
	Blinking green	Activity

Detailed Rear View

Figure 5 is an overall rear view of the Cisco UCS 6454 Fabric Interconnect.

Figure 5 6454 54-port Fabric Interconnect Chassis Overall Rear View

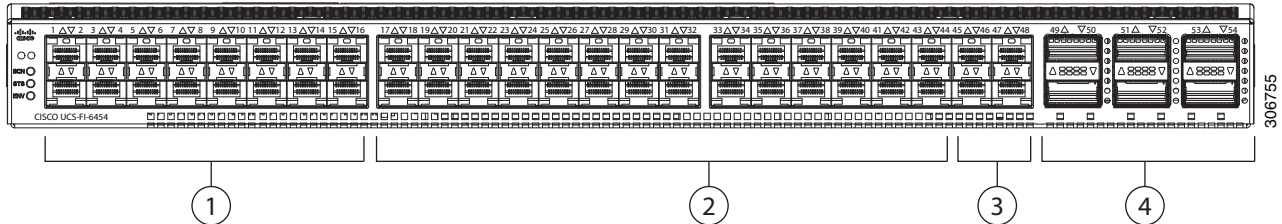

1	Ports 1-16 Unified ports support 10/25 Gbps Ethernet or FCoE or 8/16/32 Gbps FC	2	Ports 17-44 10/25 Gbps Ethernet or FCoE
3	Ports 45-48 1/10/25 Gbps Ethernet or FCoE	4	Uplink ports 49-54 40/100 Gbps Ethernet or FCoE



NOTE:

- Breakout cables are supported on ports 49-54 when connecting to N9K switches.
- From 4.1(3) release, FI 6454 and 64108 supports server-ports on the 40/100G ports after break-out (ports 49-54 and 97-108 respectively). Only direct-connect rack-servers at 10/25G speeds with VIC 1455/1457/15428 are supported on the 40/100G ports. Note that server port at 40/100G speeds are not supported. FI 6454 can support maximum of 64 server-ports and FI 64108 can support 128 server ports after breakout of 40/100G ports.

Rear LED Indicators

The rear LED indicators are described in the following sections

System Environment LED

The system environment LED is located on the left rear of the chassis (see *Figure 5 on page 7*). The LED states are shown in *Table 5*.

Table 5 System Environment LED States

LED State	Description
Solid Amber	Minor fan alarm (one fan missing or failure)
Solid red	Major fan alarm (two more fans missing or failed, or fan direction mismatch)

Ethernet Port (ports 1–48) LEDs

Figure 7 is a detailed view of one of the 40/100 Gbps Ethernet or FCoE ports and its LEDs.

Figure 6 Ethernet Port LEDs (ports 1-48)

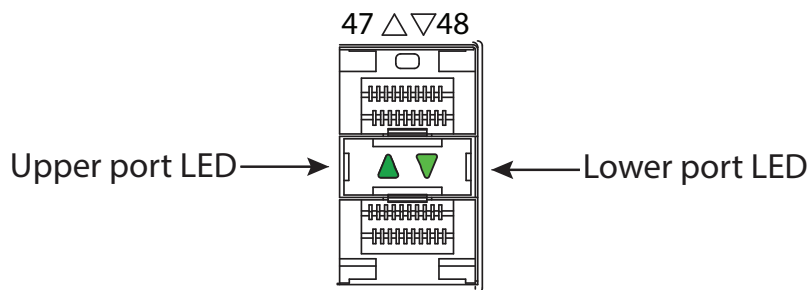

The port 1–48 LED states are shown in *Table 6*.

Table 6 Port 1 to 48 LED States

LED Position	LED State	Description
Left	Off	No link
	Solid green	Physical link
Right	Off	No activity
	Blinking green	Activity

40/100 Gbps Port (ports 49–54) LEDs

Figure 7 is an detailed view of one of the 10/25 Gbps Ethernet or FCoE ports and its LEDs.

Figure 7 40/100 Gbps Ethernet or FCoE Port LEDs (ports 49 - 54)

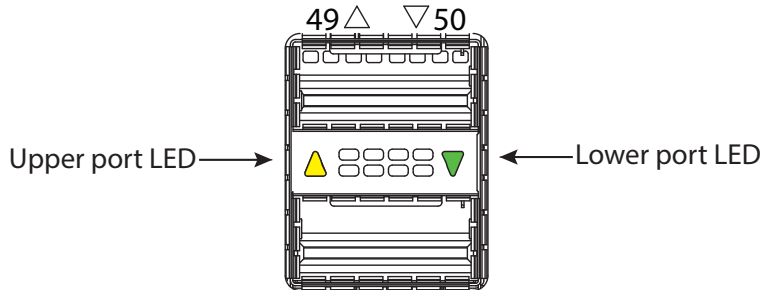

The port LED states are shown in [Table 7](#).

Table 7 Port 49 to 54 LED States

LED State	Description
Yellow	Enabled (but SFP not inserted)
Green	Enabled (and link is up)
Off	Enabled (but link not connected)
Blinking yellow	Power On Self Test (POST) failed
Blinking yellow	Port beacon enabled
Yellow	Administrative (software shut down)

Cisco UCS 64108 108-Port Fabric Interconnect

The Cisco UCS 64108 Fabric Interconnect (FI) is a 2-RU top-of-rack switch that mounts in a standard 19-inch rack such as the Cisco R Series rack. The 64108 is a 10/25/40/100 Gigabit Ethernet, FCoE and Fiber Channel switch offering up to 7.42 Tbps throughput and up to 108 ports. The switch has 16 unified ports (port numbers 1-16) that can support 10/25-Gbps SFP28 Ethernet ports or 8/16/32-Gbps Fibre Channel ports, 72 10/25-Gbps Ethernet SFP28 ports (port numbers 17-88), 8 1/10/25-Gbps Ethernet SFP28 ports (port numbers 89-96), and 12 40/100-Gbps Ethernet QSFP28 uplink ports (port numbers 97-108). All Ethernet ports are capable of supporting FCoE.

The Cisco UCS 64108 Fabric Interconnect also has one network management port, one console port for setting the initial configuration, and one USB port for saving or loading configurations. The FI also includes L1/L2 ports for connecting two fabric interconnects for high availability.

The 54-port chassis is shown in [Figure 8](#).

Figure 8 Cisco UCS Fabric Interconnect 64108 (2RU)

Front View



Rear View



Detailed Front View

The Cisco UCS 64108 front view shown in [Figure 9](#).

Figure 9 Front View of 64108

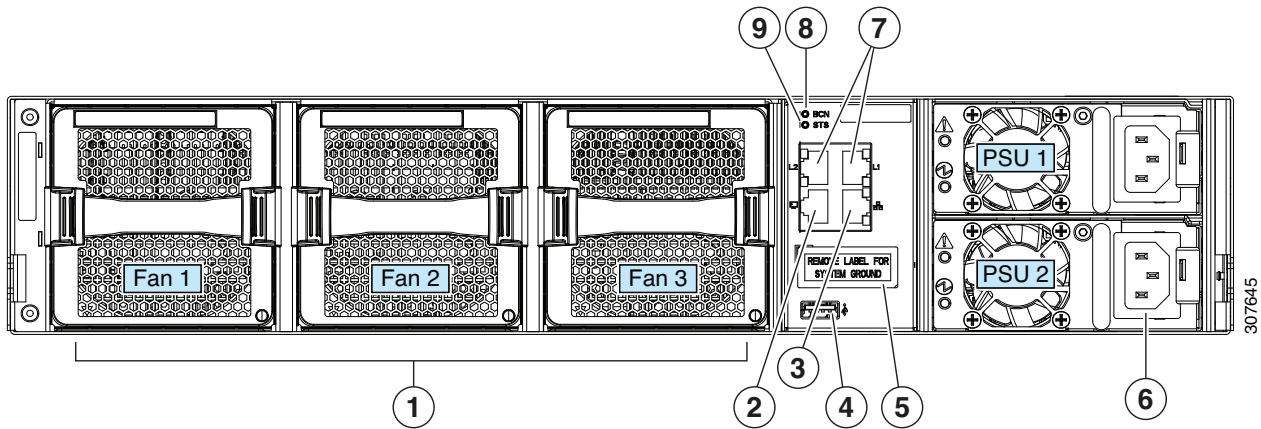

1	Cooling fans (hot swappable, 2+1 redundancy)	2	RS-232 serial console port (RJ-45 connector)
3	Network management port (RJ-45 connector)	4	USB port
5	Grounding pad for two-hole grounding lug (under protective label)	6	Power supplies Two identical AC or DC PSUs, hot-swappable, 1+1 redundancy
7	L1/L2 high-availability ports (RJ-45 connector)	8	Beacon LED
9	System status LED	—	—

Figure 10 RJ45 Connectors and USB Port

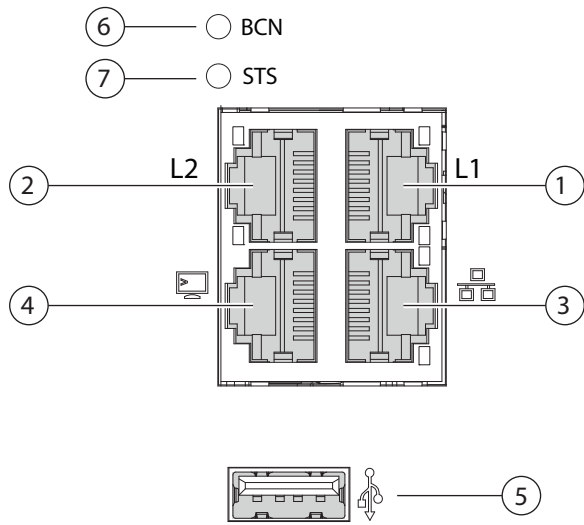

1	L1 High Availability Port	2	L2 High Availability Port
3	RJ45 Network Management Port	4	RJ45 Console Port
5	USB Port	6	Beacon LED
7	System Status LED	—	—

Figure 11 AC Power Supplies for the Cisco UCS 64108 Fabric Interconnect

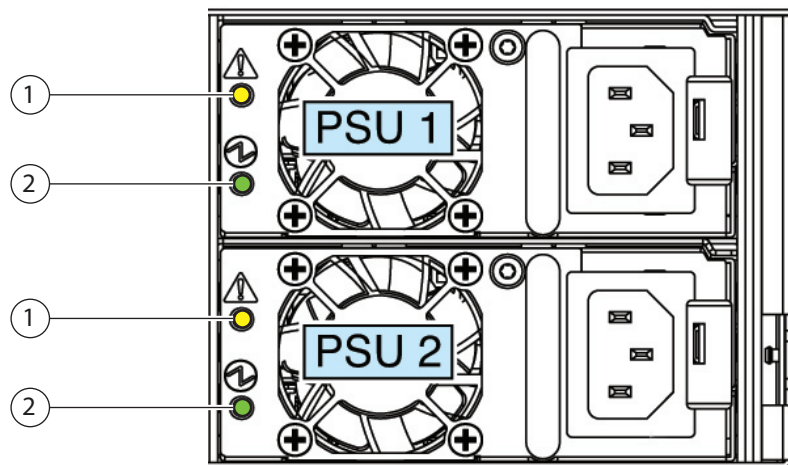

1	Amber fault/error LED	2	Green power on LED
---	-----------------------	---	--------------------

Front LED Indicators

The front LED indicators are described in the following sections

Power Supply LEDs

The power supply LEDs are located on the left front portion of the power supply (see [Figure 11 on page 12](#)). Combinations of states indicated by the Power On (🔌) and Error (⚠️) LEDs indicate the status for the module as shown in [Table 8](#)

Table 8 Power Supply LED States

Power on LED	Error LED	Status
Green	Off	Power supply is on and outputting power to the switch.
Flashing green	Off	Power supply is connected to a power source but not outputting power to the switch—power supply might not be installed in the chassis.
Off	Off	Power supply is not receiving power.
Green	Flashing amber	Power supply warning—possibly one of the following conditions: <ul style="list-style-type: none"> ■ High voltage ■ High power ■ Low voltage ■ Power supply installed in chassis but not connected to a power source ■ Slow power supply fan
Flashing green	Amber	Power supply failure—possibly one of the following conditions: <ul style="list-style-type: none"> ■ Over voltage ■ Over current ■ Over temperature ■ Power supply fan failure

Management Port LEDs

The management port LED states (see [Figure 10 on page 12](#)) are shown in [Table 9](#).

Table 9 Management Port LED States

LED Position	LED State	Description
Left	Off	No link
	Solid green	Physical link
Right	Off	No activity
	Blinking green	Activity

Beacon and System Status LEDs

The beacon and system status LED states (see [Figure 10 on page 12](#)) are shown in [Table 10](#).

Table 10 Beacon and System Status LED States

LED	Location	Function	Color	State	Description
Beacon LED	Front and rear	Identify selected chassis	Blue	Solid on	Chassis is selected
				Off	Chassis is not selected
System status LED	Front and rear	System power/health during boot up and run time	Green	Solid on	Normal operation
				Off	System is powered off
			Amber	On	System fault
			Red	Solid on	Power shut down by software
Blinking	Secure boot validation has failed				

L1/L2 Port LEDs

The L1/L2 port LED states (see [Figure 10 on page 12](#)) are shown in [Table 11](#).

Table 11 L1/L2 Port LED States

LED Position	LED State	Description
Left	Off	No link
	Solid green	Physical link
Right	Off	No activity
	Blinking green	Activity

Detailed Rear View

Figure 12 is an overall rear view of the Cisco UCS 64108 Fabric Interconnect.

Figure 12 64108 108-port Fabric Interconnect Chassis Overall Rear View

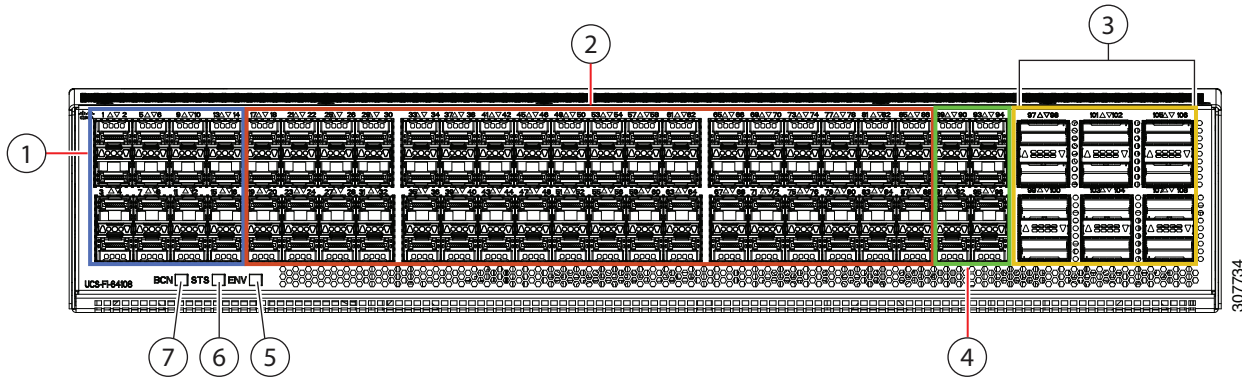

1	Ports 1-16 Unified ports that support <ul style="list-style-type: none"> ■ 10/25 Gbps Ethernet, or ■ FCoE, or ■ 8/16/32 Gbps FC 	2	Ports 17-88 10/25 Gbps Ethernet or FCoE only
3	Uplink Ports 97-108 40/100 Gbps Ethernet or FCoE Each of these ports can be 4 x 10/25 Gbps Ethernet or FCoE uplink ports when using a breakout cable.	4	Ports 89-96 1/10/25 Gbps Ethernet or FCoE
5	System environment (fan fault) LED	6	System status LED
7	Beacon LED	-	



NOTE:

- Breakout cables are supported on ports 97-108 when connecting to Nexus 9K switches.
- From 4.1(3) release, FI 6454 and 64108 supports server-ports on the 40/100G ports after break-out (ports 49-54 and 97-108 respectively). Only direct-connect rack-servers at 10/25G speeds with VIC 1455/1457/15428 are supported on the 40/100G ports. Note that server port at 40/100G speeds are not supported. FI 6454 can support maximum of 64 server-ports and FI 64108 can support 128 server ports after breakout of 40/100G ports.

Rear LED Indicators

The rear LED indicators are described in the following sections

System Environment LED

The system environment LED is located on the left rear of the chassis (see [Figure 12 on page 15](#)). The LED states are shown in [Table 5](#).

Table 12 System Environment LED States

LED State	Description
Solid Amber	Minor fan alarm (one fan missing or failure)
Solid red	Major fan alarm (two more fans missing or failed, or fan direction mismatch)

Ethernet Port (ports 1–96) LEDs

[Figure 7](#) is a detailed view of one of the 10/25 Gbps Ethernet or FCoE ports and its LEDs.

Figure 13 Ethernet Port LEDs (ports 1-48)

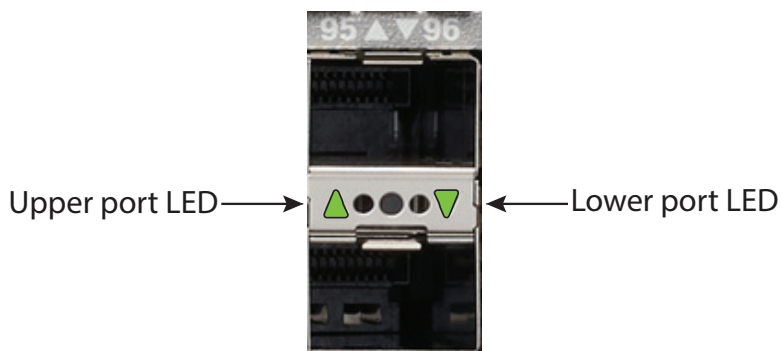

The port 1–96 LED states are shown in [Table 6](#).

Table 13 Port 1 to 96 LED States

LED Position	LED State	Description
Left	Off	No link
	Solid green	Physical link
Right	Off	No activity
	Blinking green	Activity

40/100 Gbps Port (ports 97–108) LEDs

Figure 7 is an detailed view of one of the 40/100 Gbps Ethernet or FCoE ports and its LEDs.

Figure 14 40/100 Gbps Ethernet or FCoE Port LEDs (ports 97 - 108)

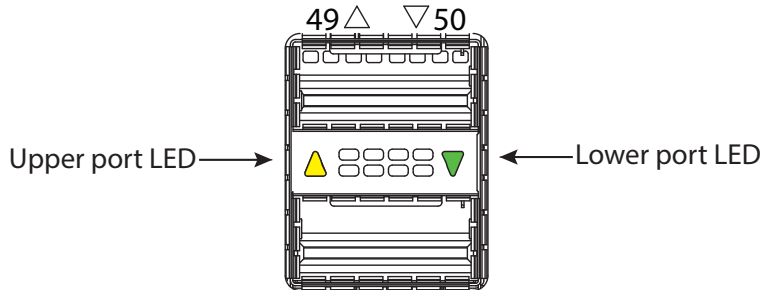

The port LED states are shown in [Table 14](#).

Table 14 Port 97 to 108 LED States

LED State	Description
Yellow	Enabled (but SFP not inserted)
Green	Enabled (and link is up)
Off	Enabled (but link not connected)
Blinking yellow	Power On Self Test (POST) failed
Blinking yellow	Port beacon enabled
Yellow	Administrative (software shut down)

Cisco UCS 6400 Series Fabric Interconnect Capabilities And Features

Table 15 lists the capabilities and features of the Cisco UCS 6400 series Fabric Interconnects. Details about how to configure this Fabric Interconnect series for a particular feature or capability are provided in *CONFIGURING the FABRIC INTERCONNECTS on page 20*.

Table 15 Capabilities and Features

Capability/Feature	Cisco UCS 6454 (54 Ports)	Cisco UCS 64108 (108 Ports)
Chassis	1RU 54-port Fabric Interconnect	2RU 108-port Fabric Interconnect
Throughput	3.82 Tbps switching performance	7.42 Tbps switching performance
Fan Modules	Four variable speed fans	Three variable speed fans
Unified Ports	16  Note: This FI supported 8 unified ports (ports 1 - 8) with Cisco UCS Manager 4.0(1) and 4.0(2), but with Release 4.0(4) and later it supports 16 unified ports (ports 1 - 16)	16
Power Supply	Two Power Supplies (AC or DC)	
Management by Cisco UCS Manager	<ul style="list-style-type: none"> ■ Increases flexibility with a range of interconnect solutions, including copper Twinax cable for short runs and fiber for long runs ■ Consumes less power per port than traditional solution ■ Helps enable cost-effective connections on fabric extenders with Cisco Fabric Extender Transceiver (FET) optics ■ Allows all elements connected to the interconnects to participate in a single, highly available management domain 	
Unified Fabric	<ul style="list-style-type: none"> ■ Decreases total cost of ownership (TCO) by reducing the number of NICs, HBAs, switches, and cables needed ■ Transparently encapsulates Fibre Channel packets into Ethernet 	
Fabric Extender Architecture	<ul style="list-style-type: none"> ■ Scales to 20 chassis without adding complexity by eliminating the need for dedicated chassis management and blade switches and by reducing the number of cables needed ■ Provides deterministic latency for optimized application performance 	
SFP+ ports	<ul style="list-style-type: none"> ■ Increases flexibility with a range of interconnect solutions, including copper Twinax cable for short runs and fiber for long runs ■ Consumes less power per port than traditional solutions ■ Helps enable cost-effective connections on fabric extenders with Cisco Fabric Extender Transceiver (FET) optics (see Table 19 on page 25). 	

Table 15 Capabilities and Features (continued)

Capability/Feature	Cisco UCS 6454 (54 Ports)	Cisco UCS 64108 (108 Ports)
SFP28-compatible ports	Allows fixed ports to be configured to operate in 10/25 Gigabit Ethernet mode with the transceiver options specified for use with SFP28-compatible ports in Table 19 on page 25 .	
QSFP28-compatible Ports	Allows all ports to be configured to operate in 40/100 Gigabit Ethernet mode with the transceiver options specified for use with QSFP28-compatible ports (see Table 19 on page 25).	
Transceivers	The Cisco UCS 6400 series FIs support a wide variety of 10/25/40/100 Gigabit Ethernet connectivity options using Cisco 10/25/40/100 Gbps modules. Unified ports (UP) on the Cisco UCS 6400 series FIs support 10/25 Gigabit Ethernet connectivity or 8/16/32 Gigabit Fibre Channel.	
Port-based Licensing	Helps enable a pay-as-you-go model, allowing customers to add capacity as the networking needs of an individual system increase	
Front-to-Back Cooling	Fan side intake, port side exhaust	
Redundant hot-swappable fans and power supplies	<ul style="list-style-type: none"> ■ Helps enable high availability in multiple configurations ■ Increases serviceability ■ Provides uninterrupted service during maintenance 	
Rear Ports	Helps keep cable lengths short and efficient	
Performance	<ul style="list-style-type: none"> ■ Provides high-speed, low-latency connectivity to the chassis ■ Provides approximately 50% reduction in end-to-end system latency (latency is less than 1 microseconds) 	
Lossless Fabric	Provides a reliable, robust foundation for unifying LAN and SAN traffic on a single transport	
Priority Flow Control (PFC)	<ul style="list-style-type: none"> ■ Simplifies management of multiple traffic flows over a single network link ■ Supports different classes of service, helping enable both lossless and classic Ethernet on the same fabric 	
Systemwide Bandwidth Management	Helps enable consistent and coherent quality of service (QoS) throughout the system	

CONFIGURING the FABRIC INTERCONNECTS

Follow these steps to configure the Cisco UCS 6400 Series Fabric Interconnect:

- *STEP 1 VERIFY FABRIC INTERCONNECT SKU, page 21*
- *STEP 2 CHOOSE PORT LICENSES (OPTIONAL), page 23*
- *STEP 3 CHOOSE TRANSCEIVERS (OPTIONAL), page 25*
- *STEP 4 CHOOSE POWER SUPPLIES, page 30*
- *STEP 5 SELECT AC POWER CORDS, page 34*
- *STEP 6 ACCESSORY KIT (INCLUDED), page 37*
- *STEP 7 CHOOSE SERVICE AND SUPPORT LEVEL, page 38*

STEP 1 VERIFY FABRIC INTERCONNECT SKU

Verify the product ID (PID) of the desired 6400 series Fabric Interconnects as shown in [Table 16](#).

Table 16 PID of the Base 6400 Series Fabric Interconnects

Product ID (PID)	Description
6454 PIDs	
UCS-FI-6454-U	Standalone model: UCS 6454 1RU Fabric Interconnect, with no PSU, with 54 ports and includes 18x10/25-Gbps and 2x40/100-Gbps port licenses
UCS-FI-6454-D-U	Standalone model: UCS 6454 1RU Fabric Interconnect, with no PSU, with 54 ports and includes 18x10/25-Gbps and 2x40/100-Gbps port licenses
UCS-FI-6454++	Standalone model: TAA-UCS 6454 1RU Fabric Interconnect, with no PSU, with 54 ports and includes 18x10/25-Gbps and 2x40/100-Gbps port licenses
UCS-FI-6454-CH	Standalone model: DISTI-UCS 6454 1RU Fabric Interconnect, with no PSU, with 54 ports and includes 18x10/25-Gbps and 2x40/100-Gbps port licenses
UCS-FI-6454=	Standalone model: Spare-UCS 6454 1RU Fabric Interconnect, with no PSU, with 54 ports and includes 18x10/25-Gbps and 2x40/100-Gbps port licenses
UCS-FI-6454	Configured model: UCS 6454 1RU Fabric Interconnect, with no PSU, with 54 ports and includes 18x10/25-Gbps and 2x40/100-Gbps port licenses
UCSX-FI-6454-U	Standalone model: UCS 6454 1RU Fabric Interconnect, with no PSU, with 54 ports and includes 18x10/25-Gbps and 2x40/100-Gbps port licenses
UCSX-FI-6454-D-U	Standalone model: UCS 6454 1RU Fabric Interconnect, with no PSU, with 54 ports and includes 18x10/25-Gbps and 2x40/100-Gbps port licenses
64108 PIDs	
UCS-FI-64108-U	Standalone model: UCS 64108 2RU Fabric Interconnect, with no PSU, with 108 ports and includes 36x10/25-Gbps and 4x40/100-Gbps port licenses
UCS-FI-64108-D-U	Standalone model: UCS 64108 2RU Fabric Interconnect, with no PSU, with 108 ports and includes 36x10/25-Gbps and 4x40/100-Gbps port licenses
UCS-FI-64108-CH	Standalone model: DISTI-UCS 64108 2RU Fabric Interconnect, with no PSU, with 108 ports and includes 36x10/25-Gbps and 4x40/100-Gbps port licenses
UCS-FI-64108=	Standalone model: Spare-UCS 64108 2RU Fabric Interconnect, with no PSU, with 108 ports and includes 36x10/25-Gbps and 4x40/100-Gbps port licenses
UCS-FI-64108	Configured model: UCS 64108 2RU Fabric Interconnect, with no PSU, with 108 ports and includes 36x10/25-Gbps and 4x40/100-Gbps port licenses
UCSX-FI-64108-U	Standalone model: UCS 64108 2RU Fabric Interconnect, with no PSU, with 108 ports and includes 36x10/25-Gbps and 4x40/100-Gbps port licenses
UCSX-FI-64108-D-U	Standalone model: UCS 64108 2RU Fabric Interconnect, with no PSU, with 108 ports and includes 36x10/25-Gbps and 4x40/100-Gbps port licenses

The base Cisco UCS 6400 series Fabric Interconnects do not include the following components. They must be selected during product ordering:

- Power supplies
- Transceivers
- Cables
- Power cords
- Warranty Services



NOTE: Use the steps on the following pages to order the desired Fabric Interconnect with the configurable components that you want configured in your order.

STEP 2 CHOOSE PORT LICENSES (OPTIONAL)

The base unit comes with a number of pre-licensed ports.

The base FI 6454 PID ships with 18x10/25-Gbps ports (up to 16 ports can support FC) pre-licensed and 2x40/100-Gbps pre-licensed ports (you can choose which ports are pre-licensed). Licenses for additional ports are available as an optional PID. Ports 45-48 can also be part of the pre-licensed ports.

The base FI 64108 PID ships with 36x10/25-Gbps ports (up to 16 ports can support FC) pre-licensed and 4x40/100-Gbps pre-licensed ports (you can choose which ports are pre-licensed). Licenses for additional ports are available as an optional PID. Ports 97-108 can also be part of the pre-licensed ports.

Select Port Licenses

The port license PIDs are shown in [Table 17](#).

Table 17 6400 Series Port License PIDs

Product ID (PID)	Description
Licenses for 6400 Series	
UCS-L-6400-25G	UCS 6400 series ONLY Fabric Int 1 Port 10/25 Gbps/FC port license
UCS-L-6400-25G=	Spare, UCS 6400 series ONLY Fabric Int 1 Port 10/25 Gbps/FC port license
UCS-L-6400-25GC	UCS 6400 series ONLY Fabric Int 1 Port 10/25 Gbps/FC port license C-direct only (used to connect directly from FI 6454 to C220, C240, C460, C480, and/or C4200)
UCS-L-6400-25GC=	Spare, UCS 6400 series ONLY Fabric Int 1 Port 10/25 Gbps/FC port license C-direct only (used to connect directly from FI 6454 to C220, C240, C460, C480, and/or C4200)
UCS-L-6400-100G	UCS 6400 series ONLY Fabric Int 1 Port 40/100 Gbps port license
UCS-L-6400-100G=	Spare, UCS 6400 series ONLY Fabric Int 1 Port 40/100 Gbps port license
UCS-L-6400-25G-D	UCS 6400 series ONLY Fabric Int 1 Port 10/25 Gbps/FC port license
UCS-L-6400-25G-D=	Spare, UCS 6400 series ONLY Fabric Int 1 Port 10/25 Gbps/FC port license
UCS-L-6400-25GC-D	UCS 6400 series ONLY Fabric Int 1 Port 10/25 Gbps/FC port license C-direct only (used to connect directly from FI 6454 to C220, C240, C460, C480, and/or C4200)
UCS-L-6400-25GC-D=	Spare, UCS 6400 series ONLY Fabric Int 1 Port 10/25 Gbps/FC port license C-direct only (used to connect directly from FI 6454 to C220, C240, C460, C480, and/or C4200)
UCS-L-6400-100G-D	UCS 6400 series ONLY Fabric Int 1 Port 40/100 Gbps port license
UCS-L-6400-100G-D=	Spare, UCS 6400 series ONLY Fabric Int 1 Port 40/100 Gbps port license

Supported Configurations

Default port licensing is summarized in [Table 18](#).

Table 18 Port Licensing Options

Component	Physical Ports	Pre-Licensed Ports	Optional Additional Licensed Ports
UCS-FI-6454 (54-port FI)	54	18 SFP28 ports 2 QSFP28 Ports	30 SFP28 ports 4 QSFP28 Ports
UCS-FI-64108 (108-port FI)	108	36 SFP28 ports 4 QSFP28 Ports	60 SFP28 ports 8 QSFP28 Ports

Caveats

- Any additional license must be added for every port added beyond the quantity 20 (6454) or 40 (64108) pre-licensed ports.
- Additional licensed ports can be located in any desired physical location (however, fibre channel ports must be physically co-located)

STEP 3 CHOOSE TRANSCEIVERS (OPTIONAL)

The Cisco UCS 6400 series supports a wide variety of 10/25/40/100 Gigabit Ethernet connectivity options using Cisco 10/25/40/100 Gbps modules. Unified ports (UP) on the Cisco UCS 6400 series support 10/25 Gigabit Ethernet connectivity or 8/16/32 Gigabit Fibre Channel modules.

Choose Transceivers

The supported transceivers for the UCS 6400 series are listed in [Table 19](#).

Table 19 UCS 6400 Series Supported Transceivers

Product ID (PID)	Description
SFP 1-Gigabit Transceivers¹	
GLC-TE	1000 BASE-T SFP transceiver module for Category 5 copper wire
GLC-SX-MMD	1000BASE-SX short wavelength; with DOM
SFP+ 10-Gbps Transceivers	
SFP-10G-SR	10GBASE-SR SFP Module
SFP-10G-SR-S	10GBASE-SR SFP Module, Enterprise-Class
SFP-10G-LR	10GBASE-LR SFP Module
SFP-10G-LR-S	10GBASE-LR SFP Module, Enterprise-Class
SFP-10G-LRM	10GBASE-LRM SFP Module
SFP-10G-ER	10GBASE-ER SFP Module
SFP-10G-ER-S	10GBASE-ER SFP Module, Enterprise-Class
SFP-10G-ZR	Cisco 10GBASE-ZR SFP10G Module for SMF
SFP-10G-ZR-S	10GBASE-ZR SFP Module, Enterprise-Class
FET-10G	10G Line Extender for FEX
SFP28 25-Gbps Transceivers	
SFP-25G-SR-S	25GBASE-SR SFP Module
SFP-10/25G-LR-S ²	10/25GBASE-LR SFP28 Module
SFP-10/25G-CSR-S	Dual Rate 10/25GBASE-CSR SFP Module
QSFP+ 40-Gbps Transceivers	
QSFP-40G-SR4	40GBASE-SR4 QSFP Transceiver Module with MPO Connector
QSFP-40G-SR4-S	40GBASE-SR4 QSFP Transceiver Module, MPO Conn, Enterprise-Class
QSFP-40G-LR4	QSFP 40GBASE-LR4 OTN Transceiver, LC, 10KM

Table 19 UCS 6400 Series Supported Transceivers (continued)

Product ID (PID)	Description
QSFP-40G-LR4-S	QSFP 40GBASE-LR4 Transceiver Module, LC, 10km, Enterprise-Class
QSFP-40G-ER4	QSFP 40GBASE-ER4 Transceiver Module, LC, 40KM
WSP-Q40GLR4L	QSFP 40G Ethernet - LR4 Lite, LC, 2KM
QSFP-4X10G-LR-S	QSFP 4x10G Transceiver Module, SM MPO, 10KM, Enterprise-Class
QSFP28 100G Transceivers	
QSFP-100G-SR4-S	100GBASE SR4 QSFP Transceiver, MPO, 100m over OM4 MMF
QSFP-100G-LR4-S	100GBASE LR4 QSFP Transceiver, LC, 10km over SMF
QSFP-40/100-SRBD	100GBASE/40GBASE SR-BiDi QSFP Transceiver, LC, 100m over OM4 MMF
QSFP-100G-SM-SR	100GBASE CWDM4 Lite QSFP Transceiver, 2km over SMF, 10-60C
QSFP-100G-DR-S	100G QSFP28 Transceiver 100GBASE-DR, 500m SMF, duplex, LC
QSFP-100G-FR-S	100G QSFP28 Transceiver 100G-FR, 2km SMF, duplex, LC
SFP+ 10G Copper Cables with Integrated Transceivers	
SFP-H10GB-CU1M	10GBASE SFP+ Cable 1 Meter, passive
SFP-H10GB-CU1-5M	10GBASE SFP+ Cable 1.5 Meter, passive
SFP-H10GB-CU2M	10GBASE SFP+ Cable 2 Meter, passive
SFP-H10GB-CU2-5M	10GBASE SFP+ Cable 2.5 Meter, passive
SFP-H10GB-CU3M	10GBASE SFP+ Cable 3 Meter, passive
SFP-H10GB-CU5M	10GBASE SFP+ Cable 5 Meter, passive
SFP-H10GB-ACU7M	10GBASE SFP+ Cable 7 Meter, passive
SFP-H10GB-ACU10M	10GBASE SFP+ Cable 10 Meter, passive
SFP-10G-AOC1M	10GBASE Active Optical SFP+ Cable, 1M
SFP-10G-AOC2M	10GBASE Active Optical SFP+ Cable, 2M
SFP-10G-AOC3M	10GBASE Active Optical SFP+ Cable, 3M
SFP-10G-AOC5M	10GBASE Active Optical SFP+ Cable, 5M
SFP-10G-AOC7M	10GBASE Active Optical SFP+ Cable, 7M
SFP-10G-AOC10M	10GBASE Active Optical SFP+ Cable, 10M
SFP28 25G Copper Cables with Integrated Transceivers	
SFP-H25G-CU1M	25GBASE-CU SFP28 Cable 1 Meter
SFP-H25G-CU2M	25GBASE-CU SFP28 Cable 2 Meter
SFP-H25G-CU3M	25GBASE-CU SFP28 Cable 3 Meter

Table 19 UCS 6400 Series Supported Transceivers (*continued*)

Product ID (PID)	Description
SFP-H25G-CU4M ³	25GBASE-CU SFP28 Cable 4 Meter
SFP-H25G-CU5M ⁴	25GBASE-CU SFP28 Cable 5 Meter
SFP-25G-AOC1M	25GBASE Active Optical SFP28 Cable, 1M
SFP-25G-AOC2M	25GBASE Active Optical SFP28 Cable, 2M
SFP-25G-AOC3M	25GBASE Active Optical SFP28 Cable, 3M
SFP-25G-AOC5M	25GBASE Active Optical SFP28 Cable, 5M
SFP-25G-AOC7M	25GBASE Active Optical SFP28 Cable, 7M
SFP-25G-AOC10M	25GBASE Active Optical SFP28 Cable, 10M
QSFP 40G Cables with Integrated Transceivers	
QSFP-H40G-CU1M	40GBASE-CR4 Passive Copper Cable, 1m
QSFP-H40G-CU3M	40GBASE-CR4 Passive Copper Cable, 3m
QSFP-H40G-CU5M	40GBASE-CR4 Passive Copper Cable, 5m
QSFP-H40G-ACU7M	40GBASE-CR4 Active Copper Cable, 7m
QSFP-H40G-ACU10M	40GBASE-CR4 Active Copper Cable, 10m
QSFP-H40G-AOC1M	40GBASE Active Optical Cable, 1m
QSFP-H40G-AOC2M	40GBASE Active Optical Cable, 2m
QSFP-H40G-AOC3M	40GBASE Active Optical Cable, 3m
QSFP-H40G-AOC5M	40GBASE Active Optical Cable, 5m
QSFP-H40G-AOC10M	40GBASE Active Optical Cable, 10m
QSFP-H40G-AOC15M	40GBASE Active Optical Cable, 15m
QSFP-4SFP10G-CU1M	QSFP to 4xSFP10G Passive Copper Splitter Cable, 1m
QSFP-4SFP10G-CU3M	QSFP to 4xSFP10G Passive Copper Splitter Cable, 3m
QSFP-4SFP10G-CU5M	QSFP to 4xSFP10G Passive Copper Splitter Cable, 5m
QSFP-4X10G-AC7M	QSFP to 4xSFP10G Active Copper Splitter Cable, 7m
QSFP-4X10G-AC10M	QSFP to 4xSFP10G Active Copper Splitter Cable, 10m
QSFP-4X10G-AOC1M	40GBASE Active Optical QSFP to 4SFP breakout Cable, 1m
QSFP-4X10G-AOC3M	40GBASE Active Optical QSFP to 4SFP breakout Cable, 3m
QSFP-4X10G-AOC5M	40GBASE Active Optical QSFP to 4SFP breakout Cable, 5m
QSFP-4X10G-AOC7M	40GBASE Active Optical QSFP to 4SFP breakout Cable, 7m

Table 19 UCS 6400 Series Supported Transceivers (continued)

Product ID (PID)	Description
QSFP-4X10G-AOC10M	40GBASE Active Optical QSFP to 4SFP breakout Cable, 10m
QSFP28 100G Cables with Integrated Transceivers	
QSFP-100G-SR1.2	100G SR1.2 BiDi QSFP Transceiver, LC, 100m OM4 MMF
QSFP-100G-CU1M	100GBASE-CR4 Passive Copper Cable, 1m
QSFP-100G-CU2M	100GBASE-CR4 Passive Copper Cable, 2m
QSFP-100G-CU3M	100GBASE-CR4 Passive Copper Cable, 3m
QSFP-100G-AOC1M	100GBASE QSFP Active Optical Cable, 1m
QSFP-100G-AOC2M	100GBASE QSFP Active Optical Cable, 2m
QSFP-100G-AOC3M	100GBASE QSFP Active Optical Cable, 3m
QSFP-100G-AOC5M	100GBASE QSFP Active Optical Cable, 5m
QSFP-100G-AOC7M	100GBASE QSFP Active Optical Cable, 7m
QSFP-100G-AOC10M	100GBASE QSFP Active Optical Cable, 10m
QSFP-100G-AOC15M	100GBASE QSFP Active Optical Cable, 15m
QSFP-100G-AOC20M	100GBASE QSFP Active Optical Cable, 20m
QSFP-100G-AOC25M	100GBASE QSFP Active Optical Cable, 25m
QSFP-100G-AOC30M	100GBASE QSFP Active Optical Cable, 30m
QSFP-4SFP25G-CU1M	100GBase QSFP to 4xSFP25G Passive Copper Splitter Cable, 1m
QSFP-4SFP25G-CU2M	100GBase QSFP to 4xSFP25G Passive Copper Splitter Cable, 2m
QSFP-4SFP25G-CU3M	100GBase QSFP to 4xSFP25G Passive Copper Splitter Cable, 3m
QSFP-4SFP25G-CU5M	100GBase QSFP to 4xSFP25G Passive Copper Splitter Cable, 5m
Fibre Channel Transceivers	
DS-SFP-FC8G-SW	8 Gbps Fibre Channel SW SFP+, LC
DS-SFP-FC8G-LW	8 Gbps Fibre Channel LW SFP+, LC
DS-SFP-FC16G-SW	16 Gbps Fibre Channel SW SFP+, LC
DS-SFP-FC16G-LW	16 Gbps Fibre Channel LW SFP+, LC
DS-SFP-FC32G-SW	32 Gbps Fibre Channel SW SFP+, LC
DS-SFP-FC32G-LW	32 Gbps Fibre Channel LW SFP+, LC

Notes

1. FI 6454 supports 1G optics on ports 45-48. FI 64108 supports 1G optics on ports 89-96.

2. SFP-10/25G-LR-S & SFP-10/25G-CSR-S works only at 25G speed on FI 6400.
S-Class transceivers (for example 10G and 40G) do not support FCoE.
3. Please note, SFP-H25G-CU4M with VIC1400/FI6400 requires UCSM/CIMC 4.1(2a) with VIC firmware 5.1(2d).
4. Please note, SFP-H25G-CU5M with VIC1400/FI6400 requires UCSM/CIMC 4.1(2a) with VIC firmware 5.1(2d).
Additionally, minimum CIMC Release 4.1(2a) is required to qualify with N9K switches

Supported Configurations

- Select as many transceivers as you have licenses (see [CHOOSE PORT LICENSES \(OPTIONAL\) on page 23](#)).
- Fibre channel ports must be physically colocated in to allow them to be selected using the UCS Manager software GUI.

Caveats

- The maximum length of fiber optic runs is limited to 300 meters. This is imposed by our use of 802.3X/802.1Qbb Priority Pauses.



NOTE:

- Transceiver modules and cables that are supported on a specific Fabric Interconnect are not always supported on all VIC adapters, IOMs, or FEXs that are compatible with that Fabric Interconnect. Detailed compatibility matrices for the transceiver modules are available here:
<https://www.cisco.com/c/en/us/support/interfaces-modules/transceiver-modules/products-device-support-tables-list.html>
 - S-Class transceivers, (for example QSFP-40G-SR4-S), do not support FCoE.
-

STEP 4 CHOOSE POWER SUPPLIES

The Cisco UCS 6400 series Fabric Interconnects use AC or DC power supplies.

Choose Power Supplies

The supported power supplies for the Cisco UCS 6400 series Fabric Interconnects are listed in [Table 20](#).

Table 20 Supported 6454 Power Supplies

Product ID (PID)	Description
Power Supplies	
UCS-PSU-6332-AC	UCS 6332/6454 Power Supply/100-240VAC (650 W)
UCS-PSU-6332-AC=	Spare, UCS 6332/6454 Power Supply/100-240VAC (650 W)
UCS-PSU-6332-DC	UCS 6332/6454 Power Supply/-48VDC (930 W)
UCS-PSU-6332-DC=	Spare, UCS 6332/6454 Power Supply/-48VDC (930 W)
UCS-PSU-6332-AC-D	UCS 6332/6454 Power Supply/100-240VAC (650 W)
UCS-PSU-6332-AC-D=	Spare, UCS 6332/6454 Power Supply/100-240VAC (650 W)
UCS-PSU-6332-DC-D	UCS 6332/6454 Power Supply/-48VDC (930 W)
UCS-PSU-6332-DC-D=	Spare, UCS 6332/6454 Power Supply/-48VDC (930 W)

Table 21 Supported 64108 Power Supplies

Product ID (PID)	Description
Power Supplies	
UCS-PSU-64108-AC	UCS 64108 Power Supply/100-240VAC
UCS-PSU-64108-AC=	Spare, UCS 64108 Power Supply/100-240VAC
UCS-PSU-6332-DC	UCS 64108 Power Supply/-48VDC
UCS-PSU-6332-DC=	Spare, UCS 64108 Power Supply/-48VDC
UCS-PSU-64108-AC-D	UCS 64108 Power Supply/100-240VAC
UCS-PSU-64108-AC-D=	Spare, UCS 64108 Power Supply/100-240VAC
UCS-PSU-6332-DC-D	UCS 64108 Power Supply/-48VDC
UCS-PSU-6332-DC-D=	Spare, UCS 64108 Power Supply/-48VDC

Supported Configurations

- (1) You must choose two identical power supplies (either two AC power supplies or two DC power supplies).
- (2) If you select DC power supplies, you must also select two DC power cords (CAB-48DC-40A-8AWG). See [Table 24 on page 34](#).

Caveats

- You cannot mix power supply types.

6454 FI Fan Module

The 6454 Fabric interconnect comes with four variable speed fans, 3+1 redundant (hot swappable).

Table 22 6454 FI Fan Module

Product ID (PID)	Description
UCS-FAN-6332	UCS 6332/6454 Fan Module
UCS-FAN-6332-D	UCS 6332/6454 Fan Module

64108 FI Fan Module

The 64108 Fabric interconnect comes with three variable speed fans, 2+1 redundant (hot swappable).

Table 23 64108 FI Fan Module

Product ID (PID)	Description
UCS-FAN-64108	UCS 64108 Fan Module
UCS-FAN-64108-D	UCS 64108 Fan Module

STEP 5 SELECT AC POWER CORDS

Select the appropriate AC power cords listed in [Table 24](#). You must select two identical power cords. If you select the option R2XX-DMYMPWRCORD, no power cord is shipped with the server.

Table 24 Available Power Cords

Product ID (PID)	PID Description	Images
R2XX-DMYMPWRCORD	No power cord (dummy PID to allow for a no power cord option)	Not applicable
CAB-AC-L620-C13	AC Power Cord, NEMA L6-20 - C13, 2M/6.5ft	
CAB-250V-10A-AR	Power Cord, 250V, 10A, Argentina	
CAB-250V-10A-BR	Power Cord - 250V, 10A - Brazil	
CAB-9K10A-AU	Power Cord, 250VAC 10A 3112 Plug, Australia	
CAB-250V-10A-CN	AC Power Cord - 250V, 10A - PRC	
CAB-9K10A-EU	Power Cord, 250VAC 10A CEE 7/7 Plug, EU	

Table 24 Available Power Cords (continued)

Product ID (PID)	PID Description	Images
CAB-250V-10A-ID	Power Cord, 250V, 10A, India	<p>Plug: EL 208</p> <p>Cordset rating 16A, 250V (2500mm)</p> <p>Connector: EL 701</p>
CAB-IND-10A	10A Power cable for India	
CAB-250V-10A-IS	Power Cord, 250V, 10A, Israel	<p>Plug: EL 212 (SI-32)</p> <p>Cordset rating 10A, 250V/500V MAX (2500 mm)</p> <p>Connector: EL 701B (IEC60320/C13)</p>
CAB-9K10A-IT	Power Cord, 250VAC 10A CEI 23-16/VII Plug, Italy	<p>Plug: ICS (CEI 23-16)</p> <p>Cordset rating: 10 A, 250 V Length: 8 ft. 2 in. (2.5 m)</p> <p>Connector: C15M (EN60320/C15)</p>
CAB-9K10A-SW	Power Cord, 250VAC 10A MP232 Plug, Switzerland	<p>Plug: MP232-R</p> <p>Cordset rating: 10 A, 250 V Length: 8 ft. 2 in (2.5 m)</p> <p>Connector: IEC 60320 C15</p>
CAB-9K10A-UK	Power Cord, 250VAC 10A BS1363 Plug (13 A fuse), UK	<p>Cordset rating: 10 A, 250 V/500 V MAX Length: 2500mm</p> <p>Plug: EL 210 (BS 1363A) 13 AMP fuse</p> <p>Connector: EL 701C (EN 60320/C15)</p>
CAB-C13-C14-2M	CABASY,WIRE,JUMPER CORD, PWR, 2 Meter, C13/C14,10A/250V	

Table 24 Available Power Cords (continued)

Product ID (PID)	PID Description	Images
CAB-9K12A-NA	Power Cord, 125VAC 13A NEMA 5-15 Plug, North America	
CAB-N5K6A-NA	Power Cord, 200/240V 6A North America	
CAB-C13-C14-AC	Power cord, C13 to C14 (recessed receptacle), 10A	
CAB-C13-CBN	CABASY,WIRE,JUMPER CORD, 27" L, C13/C14, 10A/250V	
CAB-JPN-3PIN	Power Cord 3PIN, Japan	Image not available
CAB-48DC-40A-8AWG ¹	-48VDC PSU Power Cord, 3.5M, 3 Wire, 8AWG, 40A	Image not available
CAB-C13-C14-2M	Power Cord C13-C14, 2M/6.5ft Japan PSE mark	Image not available
CAB-C13-C14-IN	Power Cord Jumper,C13-C14 Connectors,1.4 Meter Length, India	Image not available
CAB-C13-C14-3M-IN	Power Cord Jumper, C13-C14 Connectors, 3 Meter Length, India	Image not available

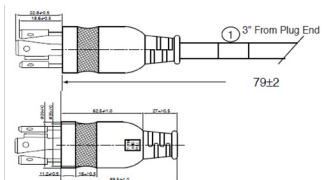
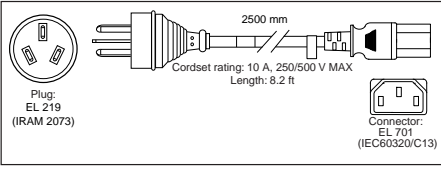
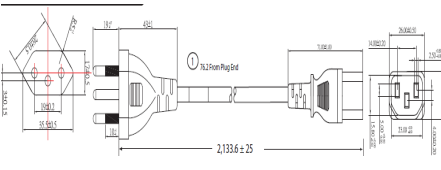
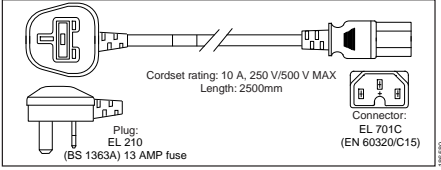
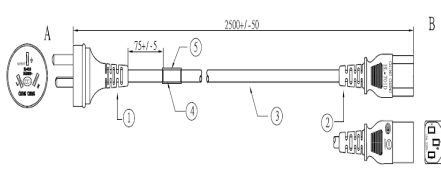
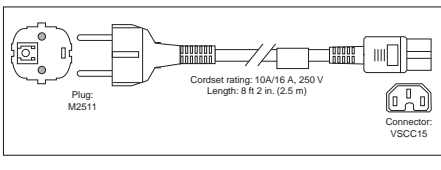
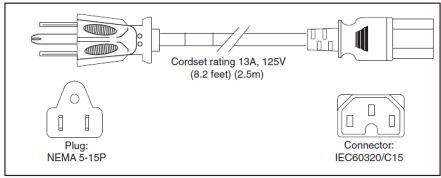
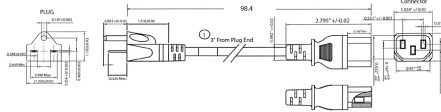
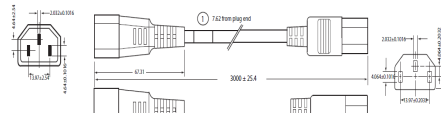
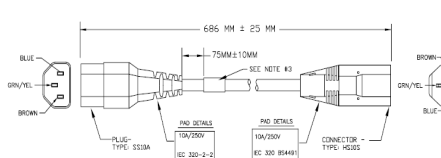
Notes

1. A minimum of two DC power cables must be selected.

STEP 6 ACCESSORY KIT (INCLUDED)

An accessory kit is included for the Cisco UCS 6454 and 64108 Fabric Interconnects.

Choose Accessory Kit

The supported accessory kits for the Cisco UCS 6400 series Fabric Interconnects are listed in [Table 25](#). The FI 6454 uses the same accessory kit as FI 6300 series.

Table 25 Accessory Kit

Product ID (PID)	Description
6454 Accessory Kit	
UCS-ACC-6332	UCS 6332/6454 Chassis Accessory Kit
UCS-ACC-6332=	Spare, UCS 6332/6454 Chassis Accessory Kit
UCS-ACC-6332-D	UCS 6332/6454 Chassis Accessory Kit
UCS-ACC-6332-D=	Spare, UCS 6332/6454 Chassis Accessory Kit
64108 Accessory Kit	
UCS-ACC-64108	UCS 64108 Chassis Accessory Kit
UCS-ACC-64108=	Spare, UCS 64108 Chassis Accessory Kit
UCS-ACC-64108-D	UCS 64108 Chassis Accessory Kit
UCS-ACC-64108-D=	Spare, UCS 64108 Chassis Accessory Kit

The Cisco UCS 6400 series Fabric Interconnect accessory kit includes the following items:

- 2 slider rails
- 2 rack-mount guides
- 2 rack-mount brackets
- 12 M4 x 0.7 x 8-mm Phillips countersunk screws
- 10 10-32 rack nuts
- 10 10-32 x 3/4-inch Phillips pan-head screws
- 1 console cable with an RJ-45-RS-232 adapter and a DB9 adapter
- 1 ground lug kit
- 1 ESD wrist strap
- 1 power cord clip (a wire clip that is used to retain the power cord)
- 1 pointer document (specifies where to find the online product documentation)

STEP 7 CHOOSE SERVICE AND SUPPORT LEVEL

A variety of service options are available, as described in this section.

Unified Computing Warranty, No Contract

If you have noncritical implementations and choose to have no service contract, the following coverage is supplied:

- Three-year parts coverage.
- Next business day (NBD) onsite parts replacement eight hours a day, five days a week.
- 90-day software warranty on media.
- Ongoing downloads of BIOS, drivers, and firmware updates.
- UCSM updates for systems with Unified Computing System Manager. These updates include minor enhancements and bug fixes that are designed to maintain the compliance of UCSM with published specifications, release notes, and industry standards.

Smart Net Total Care (SNTC) for UCS

For support of the entire Unified Computing System, Cisco offers the Cisco Smart Net Total Care for UCS Service. This service provides expert software and hardware support to help sustain performance and high availability of the unified computing environment. Access to Cisco Technical Assistance Center (TAC) is provided around the clock, from anywhere in the world

For systems that include Unified Computing System Manager, the support service includes downloads of UCSM upgrades. The Cisco Smart Net Total Care for UCS Service includes flexible hardware replacement options, including replacement in as little as two hours. There is also access to Cisco's extensive online technical resources to help maintain optimal efficiency and uptime of the unified computing environment. For more information please refer to the following url: <http://www.cisco.com/c/en/us/services/technical/smart-net-total-care.html?stickynav=1>

You can choose a desired service listed in [Table 26](#).

Table 26 Cisco SNTC for UCS Service (PID UCSC-FI-6454 and UCS-FI-64108)

Service SKU	Service Level GSP	On Site?	Description
CON-PREM-CSFI6454	C2P	Yes	SNTC 24X7X20S
CON-PREM-SFI64108	C2P	Yes	SNTC 24X7X20S
CON-OSP-CSFI6454	C4P	Yes	SNTC 24X7X40S
CON-OSP-SFI64108	C4P	Yes	SNTC 24X7X40S
CON-UCSD7-CSFI6454	UCSD7	Yes	UCS DR 24X7X40S*
CON-UCSD7-SFI64108	UCSD7	Yes	UCS DR 24X7X40S*
CON-C4PL-CSFI6454	C4PL	Yes	LL 24X7X40S**
CON-C4PL-SFI64108	C4PL	Yes	LL 24X7X40S**
CON-USD7L-CSFI6454	USD7L	Yes	LLUCS HW DR 24X7X40S***

Table 26 Cisco SNTC for UCS Service (PID UCSC-FI-6454 and UCS-FI-64108)

Service SKU	Service Level GSP	On Site?	Description
CON-USD7L-SFI64108	USD7L	Yes	LLUCS HW DR 24X7X4OS***
CON-OSE-CSFI6454	C4S	Yes	SNTC 8X5X4OS
CON-OSE-SFI64108	C4S	Yes	SNTC 8X5X4OS
CON-UCSD6-CSFI6454	UCSD6	Yes	UC SUPP DR 8X5X4OS*
CON-UCSD6-SFI64108	UCSD6	Yes	UC SUPP DR 8X5X4OS*
CON-SNCO-CSFI6454	SNCO	Yes	SNTC 8x7xNCDOS****
CON-SNCO-SFI64108	SNCO	Yes	SNTC 8x7xNCDOS****
CON-OS-CSFI6454	CS	Yes	SNTC 8X5XNBDOS
CON-OS-SFI64108	CS	Yes	SNTC 8X5XNBDOS
CON-UCSD5-CSFI6454	UCSD5	Yes	UCS DR 8X5XNBDOS*
CON-UCSD5-SFI64108	UCSD5	Yes	UCS DR 8X5XNBDOS*
CON-S2P-CSFI6454	S2P	No	SNTC 24X7X2
CON-S2P-SFI64108	S2P	No	SNTC 24X7X2
CON-SNTP-CSFI6454	SNTP	No	SNTC 24X7X4
CON-SNTP-SFI64108	SNTP	No	SNTC 24X7X4
CON-SNTPL-CSFI6454	SNTPL	No	LL 24X7X4**
CON-SNTPL-SFI64108	SNTPL	No	LL 24X7X4**
CON-SNTE-CSFI6454	SNTE	No	SNTC 8X5X4
CON-SNTE-SFI64108	SNTE	No	SNTC 8X5X4
CON-SNC-CSFI6454	SNC	No	SNTC 8x7xNCD****
CON-SNC-SFI64108	SNC	No	SNTC 8x7xNCD****
CON-SNT-CSFI6454	SNT	No	SNTC 8X5XNBD
CON-SNT-SFI64108	SNT	No	SNTC 8X5XNBD
CON-SW-CSFI6454	SW	No	SNTC NO RMA
CON-SW-SFI64108	SW	No	SNTC NO RMA

Note: For PID UCS-FI-6454-CH, select Service SKU with FI6454CH suffix (Example: CON-OSP-FI6454CH)

For PID UCS-FI-64108-CH, select Service SKU with I64108CH suffix (Example: CON OSP-I64108CH)

Note: For PID UCS-FI-6454-U, select Service SKU with SFI6454U suffix (Example: CON-OSPT-SFI6454U)

For PID UCS-FI-64108-U, select Service SKU with FI64108U suffix (Example: CON OSP-FI64108U)

Table 26 Cisco SNTC for UCS Service (PID UCSC-FI-6454 and UCS-FI-64108)

Service SKU	Service Level GSP	On Site?	Description
*Includes Drive Retention (see below for full description)			
**Includes Local Language Support (see below for full description) - Only available in China and Japan			
***Includes Local Language Support and Drive Retention - Only available in China and Japan			
****Available in China Only			

Smart Net Total Care for Cisco UCS Onsite Troubleshooting Service

An enhanced offer over traditional Smart Net Total Care which provides onsite-troubleshooting expertise to aid in the diagnostics and isolation of hardware issue within our customers’ Cisco Unified Computing System (UCS) environment. It is delivered by a Cisco Certified field engineer (FE) in collaboration with remote TAC engineer and Virtual Internet working Support Engineer (VISE). You can choose a desired service listed in [Table 27](#)

Table 27 SNTC for Cisco UCS Onsite Troubleshooting Service (PID UCSC-FI-6454 and UCS-FI-64108)

Service SKU	Service Level GSP	On Site?	Description
CON-OSPT-CSFI6454	OSPT	Yes	24X7X4OS Trblshtg
CON-OSPT-SFI64108	OSPT	Yes	24X7X4OS Trblshtg
CON-OSPTD-CSFI6454	OSPTD	Yes	24X7X4OS TrblshtgDR*
CON-OSPTD-SFI64108	OSPTD	Yes	24X7X4OS TrblshtgDR*

Note: For PID UCS-FI-6454-CH, select Service SKU with FI6454CH suffix (Example: CON-OSPT-FI6454CH)
 For PID UCS-FI-64108-CH, select Service SKU with I64108CH suffix (Example: CON OSPT-I64108CH)
 Note: For PID UCS-FI-6454-U, select Service SKU with SFI6454U suffix (Example: CON-OSPT-SFI6454U)
 For PID UCS-FI-64108-CH, select Service SKU with I64108CH suffix (Example: CON OSPT-I64108CH)
 *Includes Drive Retention (see below for full description)

Solution Support for UCS

Solution Support includes both Cisco product support and solution-level support, resolving complex issues in multivendor environments, on average, 43% more quickly than product support alone. Solution Support is a critical element in data center administration, to help rapidly resolve any issue encountered, while maintaining performance, reliability, and return on investment.

This service centralizes support across your multivendor Cisco environment for both our products and solution partner products you've deployed in your ecosystem. Whether there is an issue with a Cisco or solution partner product, just call us. Our experts are the primary point of contact and own the case from first call to resolution. For more information please refer to the following url:

<http://www.cisco.com/c/en/us/services/technical/solution-support.html?stickynav=1>

You can choose a desired service listed in [Table 28](#)

Table 28 Solution Support for UCS Service (PID UCSC-FI-6454 and UCS-FI-64108)

Service SKU	Service Level GSP	On Site?	Description
CON-SSC2P-CSFI6454	SSC2P	Yes	SOLN SUPP 24X7X2OS
CON-SSC2P-SFI64108	SSC2P	Yes	SOLN SUPP 24X7X2OS
CON-SSC4P-CSFI6454	SSC4P	Yes	SOLN SUPP 24X7X4OS
CON-SSC4P-SFI64108	SSC4P	Yes	SOLN SUPP 24X7X4OS
CON-SSC4S-CSFI6454	SSC4S	Yes	SOLN SUPP 8X5X4OS
CON-SSC4S-SFI64108	SSC4S	Yes	SOLN SUPP 8X5X4OS
CON-SSCS-CSFI6454	SSCS	Yes	SOLN SUPP 8X5XNBDOS
CON-SSCS-SFI64108	SSCS	Yes	SOLN SUPP 8X5XNBDOS
CON-SSDR7-CSFI6454	SSDR7	Yes	SSPT DR 24X7X4OS*
CON-SSDR7-SFI64108	SSDR7	Yes	SSPT DR 24X7X4OS*
CON-SSDR5-CSFI6454	SSDR5	Yes	SSPT DR 8X5XNBDOS*
CON-SSDR5-SFI64108	SSDR5	Yes	SSPT DR 8X5XNBDOS*
CON-SSS2P-CSFI6454	SSS2P	No	SOLN SUPP 24X7X2
CON-SSS2P-SFI64108	SSS2P	No	SOLN SUPP 24X7X2
CON-SSSNP-CSFI6454	SSSNP	No	SOLN SUPP 24X7X4
CON-SSSNP-SFI64108	SSSNP	No	SOLN SUPP 24X7X4
CON-SSSNE-CSFI6454	SSSNE	No	SOLN SUPP 8X5X4
CON-SSSNE-SFI64108	SSSNE	No	SOLN SUPP 8X5X4
CON-SSSNC-CSFI6454	SSSNC	No	SOLN SUPP NCD

Table 28 Solution Support for UCS Service (PID UCSC-FI-6454 and UCS-FI-64108) (continued)

CON-SSSNC-SFI64108	SSSNC	No	SOLN SUPP NCD
CON-SSSNT-CSFI6454	SSSNT	No	SOLN SUPP 8X5XNBD
Note: For PID UCS-FI-6454-CH, select Service SKU with FI6454CH suffix (Example: CON-SSC4P-FI6454CH)			
For PID UCS-FI-64108-CH, select Service SKU with I64108CH suffix (Example: CON-SSC4P-I64108CH)			
Note: For PID UCS-FI-6454-U, select Service SKU with SFI6454U suffix (Example: CON-SSC4P-SFI6454U)			
For PID UCS-FI-64108-U, select Service SKU with FI64108U suffix (Example: CON-SSC4P-FI64108U)			
*Includes Drive Retention (see below for description)			

Smart Net Total Care for UCS Hardware Only Service

For faster parts replacement than is provided with the standard Cisco Unified Computing System warranty, Cisco offers the Cisco Smart Net Total Care for UCS Hardware Only Service. You can choose from two levels of advanced onsite parts replacement coverage in as little as four hours. Smart Net Total Care for UCS Hardware Only Service provides remote access any time to Cisco support professionals who can determine if a return materials authorization (RMA) is required. You can choose a desired service listed in [Table 29](#)

Table 29 SNTC for UCS Hardware Only Service (PID UCSC-FI-6454 and UCS-FI-64108)

Service SKU	Service Level GSP	On Site?	Description
CON-UCW7-CSFI6454	UCW7	Yes	UCS HW 24X7X40S
CON-UCW7-SFI64108	UCW7	Yes	UCS HW 24x7x40S
CON-UCWD7-CSFI6454	UCWD7	Yes	UCS HW+DR 24X7X40S*
CON-UCWD7-SFI64108	UCWD7	Yes	UCS HW+DR 24X7X40S*
CON-UCW5-CSFI6454	UCW5	Yes	UCS HW 8X5XNBDOS
CON-UCW5-SFI64108	UCW5	Yes	UCS HW 8X5XNBDOS
CON-UCWD5-CSFI6454	UCWD5	Yes	UCS HW+DR 8X5XNBDOS*
CON-UCWD5-SFI64108	UCWD5	Yes	UCS HW+DR 8X5XNBDOS*
Note: For PID UCS-FI-6454-CH, select Service SKU with FI6454CH suffix (Example: CON-UCW7-FI6454CH)			
For PID UCS-FI-64108-CH, select Service SKU with I64108CH suffix (Example: CON-UCW7-I64108CH)			
Note: For PID UCS-FI-6454-U, select Service SKU with SFI6454U suffix (Example: CON-UCW7-SFI6454U)			
For PID UCS-FI-6454-U, select Service SKU with FI64108U suffix (Example: CON-UCW7-FI64108U)			
*Includes Drive Retention (see below for description)			

Partner Support Service for UCS

Cisco Partner Support Service (PSS) is a Cisco Collaborative Services service offering that is designed for partners to deliver their own branded support and managed services to enterprise customers. Cisco PSS provides partners with access to Cisco's support infrastructure and assets to help them:

- Expand their service portfolios to support the most complex network environments
- Lower delivery costs
- Deliver services that increase customer loyalty

PSS options enable eligible Cisco partners to develop and consistently deliver high-value technical support that capitalizes on Cisco intellectual assets. This helps partners to realize higher margins and expand their practice.

PSS is available to all Cisco PSS partners.

The two Partner Unified Computing Support Options include:

- Partner Support Service for UCS
- Partner Support Service for UCS Hardware Only

PSS for UCS provides hardware and software support, including triage support for third party software, backed by Cisco technical resources and level three support. You can choose a desired service listed in [Table 30](#).

Table 30 PSS for UCS (PID UCSC-FI-6454 and UCS-FI-64108)

Service SKU	Service Level GSP	On Site?	Description
CON-PSJ8-CSFI6454	PSJ8	Yes	UCS PSS 24X7X2 OS
CON-PSJ8-SFI64108	PSJ8	Yes	UCS PSS 24X7X2 OS
CON-PSJ7-CSFI6454	PSJ7	Yes	UCS PSS 24X7X4 OS
CON-PSJ7-SFI64108	PSJ7	Yes	UCS PSS 24X7X4 OS
CON-PSJD7-CSFI6454	PSJD7	Yes	UCS PSS 24X7X4 DR*
CON-PSJD7-SFI64108	PSJD7	Yes	UCS PSS 24X7X4 DR*
CON-PSJ6-CSFI6454	PSJ6	Yes	UCS PSS 8X5X4 OS
CON-PSJ6-SFI64108	PSJ6	Yes	UCS PSS 8X5X4 OS
CON-PSJD6-CSFI6454	PSJD6	Yes	UCS PSS 8X5X4 DR*
CON-PSJD6-SFI64108	PSJD6	Yes	UCS PSS 8X5X4 DR*
CON-PSJ4-CSFI6454	PSJ4	No	UCS SUPP PSS 24X7X2
CON-PSJ4-SFI64108	PSJ4	No	UCS SUPP PSS 24X7X2
CON-PSJ3-CSFI6454	PSJ3	No	UCS SUPP PSS 24X7X4

Table 30 PSS for UCS (PID UCSC-FI-6454 and UCS-FI-64108)

CON-PSJ3-SFI64108	PSJ3	No	UCS SUPP PSS 24X7X4
CON-PSJ2-CSFI6454	PSJ2	No	UCS SUPP PSS 8X5X4
CON-PSJ2-SFI64108	PSJ2	No	UCS SUPP PSS 8X5X4
CON-PSJ1-CSFI6454	PSJ1	No	UCS SUPP PSS 8X5XNBD
CON-PSJ1-SFI64108	PSJ1	No	UCS SUPP PSS 8X5XNBD

Note: For PID UCS-FI-6454-CH, select Service SKU with FI6454CH suffix (Example: CON-PSJ7-FI6454CH)

For PID UCS-FI-64108-CH, select Service SKU with I64108CH suffix (Example: CON-PSJ7-I64108CH)

Note: For PID UCS-FI-6454-U, select Service SKU with SFI6454U suffix (Example: CON-PSJ7-SFI6454U)

For PID UCS-FI-64108-U, select Service SKU with FI64109U suffix (Example: CON-PSJ7-FI64108U)

*Includes Drive Retention (see below for description)

PSS for UCS Hardware Only

PSS for UCS Hardware Only provides customers with replacement parts in as little as two hours and provides remote access any time to Partner Support professionals who can determine if a return materials authorization (RMA) is required. You can choose a desired service listed in

[Table 31](#)

Table 31 PSS for UCS Hardware Only (PID UCSC-FI-6454 and UCS-FI-64108)

Service SKU	Service Level GSP	On Site?	Description
CON-PSW7-CSFI6454	PSW7	Yes	UCS W PSS 24X7X4 OS
CON-PSW7-SFI64108	PSW7	Yes	UCS W PSS 24X7X4 OS
CON-PSWD7-CSFI6454	PSWD7	Yes	UCS W PSS 24X7X4 DR*
CON-PSWD7-SFI64108	PSWD7	Yes	UCS W PSS 24X7X4 DR*
CON-PSW6-CSFI6454	PSW6	Yes	UCS W PSS 8X5X4 OS
CON-PSW6-SFI64108	PSW6	Yes	UCS W PSS 8X5X4 OS
CON-PSWD6-CSFI6454	PSWD6	Yes	UCS W PSS 8X5X4 DR*
CON-PSWD6-SFI64108	PSWD6	Yes	UCS W PSS 8X5X4 DR*
CON-PSW4-CSFI6454	PSW4	No	UCS W PL PSS 24X7X2
CON-PSW4-SFI64108	PSW4	No	UCS W PL PSS 24X7X2
CON-PSW3-CSFI6454	PSW3	No	UCS W PL PSS 24X7X4
CON-PSW3-SFI64108	PSW3	No	UCS W PL PSS 24X7X4
CON-PSW2-CSFI6454	PSW2	No	UCS W PL PSS 8X5X4

Table 31 PSS for UCS Hardware Only (PID UCSC-FI-6454 and UCS-FI-64108)

CON-PSW2-SFI64108	PSW2	No	UCS W PL PSS 8X5X4
Note: For PID UCS-FI-6454-CH, select Service SKU with FI6454CH suffix (Example: CON-PSW7-FI6454CH)			
For PID UCS-FI-64108-CH, select Service SKU with I64108CH suffix (Example: CON-PSW7-I64108CH)			
Note: For PID UCS-FI-6454-U, select Service SKU with SFI6454U suffix (Example: CON-PSW7-SFI6454U)			
For PID UCS-FI64108-U, select Service SKU with FI64108U suffix (Example: CON-PSW7-FI64108U)			
*Includes Drive Retention (see below for description)			

Unified Computing Combined Support Service

Combined Services makes it easier to purchase and manage required services under one contract. SNTC services for UCS help increase the availability of your vital data center infrastructure and realize the most value from your unified computing investment. The more benefits you realize from the Cisco Unified Computing System (Cisco UCS), the more important the technology becomes to your business. These services allow you to:

- Optimize the uptime, performance, and efficiency of your UCS
- Protect your vital business applications by rapidly identifying and addressing issues
- Strengthen in-house expertise through knowledge transfer and mentoring
- Improve operational efficiency by allowing UCS experts to augment your internal staff resources
- Enhance business agility by diagnosing potential issues before they affect your operations,

You can choose a desired service listed in [Table 32](#).

Table 32 Combined Support Service for UCS (PID UCSC-FI-6454 and UCS-FI-64108)

Service SKU	Service Level GSP	On Site?	Description
CON-NCF2P-CSFI6454	NCF2P	Yes	CMB SVC 24X7X20S
CON-NCF2P-SFI64108	NCF2P	Yes	CMB SVC 24X7X20S
CON-NCF4P-CSFI6454	NCF4P	Yes	CMB SVC 24X7X40S
CON-NCF4P-SFI64108	NCF4P	Yes	CMB SVC 24X7X40S
CON-NCF4S-CSFI6454	NCF4S	Yes	CMB SVC 8X5X40S
CON-NCF4S-SFI64108	NCF4S	Yes	CMB SVC 8X5X40S
CON-NCFCS-CSFI6454	NCFCS	Yes	CMB SVC 8X5XNBDOS
CON-NCFCS-SFI64108	NCFCS	Yes	CMB SVC 8X5XNBDOS
CON-NCF2-CSFI6454	NCF2	No	CMB SVC 24X7X2

Table 32 Combined Support Service for UCS (PID UCSC-FI-6454 and UCS-FI-64108)

CON-NCF2-SFI64108	NCF2	No	CMB SVC 24X7X2
CON-NCFP-CSFI6454	NCFP	No	CMB SVC 24X7X4
CON-NCFP-SFI64108	NCFP	No	CMB SVC 24X7X4
CON-NCFE-CSFI6454	NCFE	No	CMB SVC 8X5X4
CON-NCFE-SFI64108	NCFE	No	CMB SVC 8X5X4
CON-NCFT-CSFI6454	NCFT	No	CMB SVC 8X5XNBD
CON-NCFT-SFI64108	NCFT	No	CMB SVC 8X5XNBD
CON-NCFW-CSFI6454	NCFW	No	CMB SVC SW
CON-NCFW-SFI64108	NCFW	No	CMB SVC SW

Note: For PID UCS-FI-6454-CH, select Service SKU with FI6454CH suffix (Example: CON-NCF4P-FI6454CH)
 For PID UCS-FI-64108-CH, select Service SKU with I64108CH suffix (Example: CON-NCF4P-I64108CH)
 Note: For PID UCS-FI-6454-U, select Service SKU with SFI6454U suffix (Example: CON-NCF4P-SFI6454U)
 For PID UCS-FI-64108-U, select Service SKU with FI64108U suffix (Example: CON-NCF4P-FI64108U)

UCS Drive Retention Service

With the Cisco Unified Computing Drive Retention Service, you can obtain a new disk drive in exchange for a faulty drive without returning the faulty drive.

Sophisticated data recovery techniques have made classified, proprietary, and confidential information vulnerable, even on malfunctioning disk drives. The Drive Retention service enables you to retain your drives and ensures that the sensitive data on those drives is not compromised, which reduces the risk of any potential liabilities. This service also enables you to comply with regulatory, local, and federal requirements.

If your company has a need to control confidential, classified, sensitive, or proprietary data, you might want to consider one of the Drive Retention Services listed in the above tables (where available)



NOTE: Cisco does not offer a certified drive destruction service as part of this service.

Local Language Technical Support for UCS

Where available, and subject to an additional fee, local language support for calls on all assigned severity levels may be available for specific product(s) - see tables above.

For a complete listing of available services for Cisco Unified Computing System, see this URL: http://www.cisco.com/en/US/products/ps10312/serv_group_home.html

SUPPLEMENTAL MATERIAL



NOTE:

Cisco UCS 6454 Port Numbering

Each port on the Cisco UCS 6454 is numbered, and groups of ports are numbered based on their function. The ports are numbered top to bottom and left to right.

Figure 15 shows how ports are numbered and the table below explains how each port group functions.

Figure 15 Port Numbering of the Cisco UCS 6454

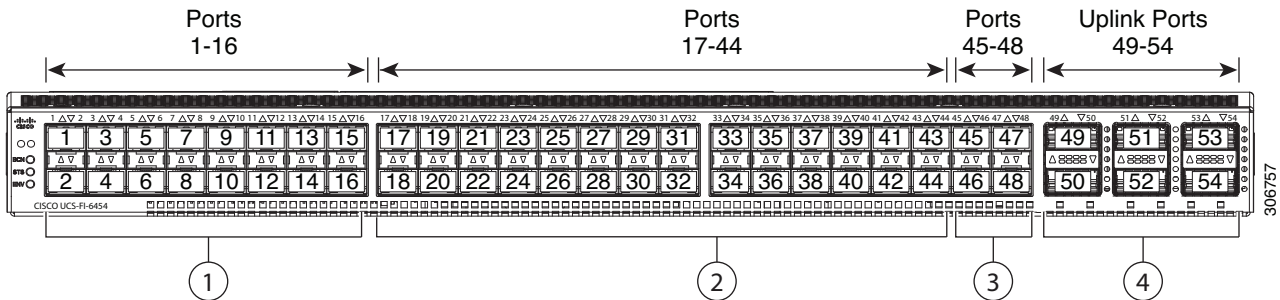

1	Ports 1–16 are Universal ports (operate either as 10/25 Gbps SFP28 fixed Ethernet or as 8/16/32 Gbps Fibre channel)	2	Ports 17-44 operate as 10/25 Gbps SFP28 Ethernet/FCoE ports.
3	Port 45-48 (operate as 1/10/25 Gbps SFP28 Ethernet/FCoE ports)	4	Port 49-54 (operate as 40/100 Gbps QSFP28 Ethernet/FCoE ports) ^{1,2}

Notes

- Ports 49–54 ports do not support QSA module.
- From 4.1(3) release, FI 64108 supports server-ports on the 40/100G ports after break-out ports 49-54 Only direct-connect rack-servers at 10/25G speeds with VIC 1455/1457/15428 are supported on the 40/100G ports. Note that server port at 40/100G speeds are not supported. FI 6454 can support maximum of 64 server-ports after breakout of 40/100G ports.

Cisco UCS 64108 Port Numbering

Each port on the Cisco UCS 64108 is numbered, and groups of ports are numbered based on their function. The ports are numbered top to bottom and left to right.

Figure 15 shows how ports are numbered and the table below explains how each port group functions.

Figure 16 Port Numbering of the Cisco UCS 64108

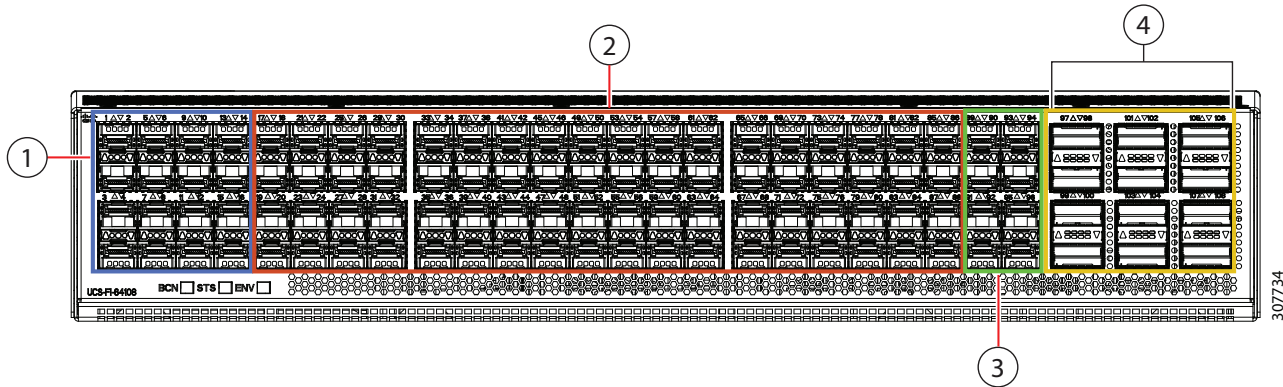

1	5	9	13	17	21	25	29	33	37	41	45	49	53	57	61	65	69	73	77	81	85	89	93	97	101	105
2	6	10	14	18	22	26	30	34	38	42	46	50	54	58	62	66	70	74	78	82	86	90	94	98	102	106
3	7	11	15	19	23	27	31	35	39	43	47	51	55	59	63	67	71	75	79	83	87	91	95	99	103	107
4	8	12	16	20	24	28	32	36	40	44	48	52	56	60	64	68	72	76	80	84	88	92	96	100	104	108

1	Ports 1–16 are Universal ports (operate either as 10/25 Gbps SFP28 fixed Ethernet or as 8/16/32 Gbps Fibre channel)	2	Ports 17-88 operate as 10/25 Gbps SFP28 Ethernet/FCoE ports.
3	Port 89-96 (operate as 1/10/25 Gbps SFP28 Ethernet/FCoE ports)	4	Port 97-108 (operate as 40/100 Gbps QSFP28 Ethernet/FCoE ports) ^{1,2}

Notes

- Ports 97–108 do not support QSA module.
- From 4.1(3) release, 64108 supports server-ports on the 40/100G ports after break-out ports 97-108 Only direct-connect rack-servers at 10/25G speeds with VIC 1455/1457/15428 are supported on the 40/100G ports. Note that server port at 40/100G speeds are not supported. FI 64108 can support 128 server ports after breakout of 40/100G ports.

Cisco UCS 6454 Supported Speeds

Speed	Port Range			
	1-16	17-44	45-48	49-54
1 Gbps	No	No	Yes	No
10/25 Gbps	Yes	Yes	Yes	No
40/100 Gbps	No	No	No	Yes
8/16/32 Gbps FC	Yes	No	No	No

Cisco UCS 64108 Supported Speeds

Speed	Port Range			
	1-16	17-88	89-96	97-108
1 Gbps	No	No	Yes	No
10/25 Gbps	Yes	Yes	Yes	No
40/100 Gbps	No	No	No	Yes
8/16/32 Gbps FC	Yes	No	No	No

Connectivity

This section explains the connectivity between the Fabric Interconnects (FIs) and Fabric Extenders (FEX). The Fabric Extenders are extensions of the Fabric Interconnects and act as remote line cards to form a distributed modular fabric system. The fabric extension is accomplished through the FEX fabric link, which is the connection between the Fabric Interconnect and the FEX.

A minimum of one connection between the FI and FEX is required to provide server connectivity. Depending on the FEX model, subsequent connections can be up to eight links, which provides added bandwidth to the servers.

9508 Chassis Server Connectivity

For the X9508 chassis, the Fabric Extender modules (up to two) plug into the back of the UCS X9508 chassis. There is no backplane in the Cisco UCS X9508 chassis; the compute nodes directly connect to the IFMs using Orthogonal Direct connectors. The X9508 chassis accommodates the following IFMs:

- Cisco IFM 9108-25G (Figure 17)

The connectivity from the X9108-IFM-25G to 6536 Fabric Interconnects is shown in Figure 17.

Figure 17 X9108-IFM-25G to 6400 series Fabric Interconnect Connectivity

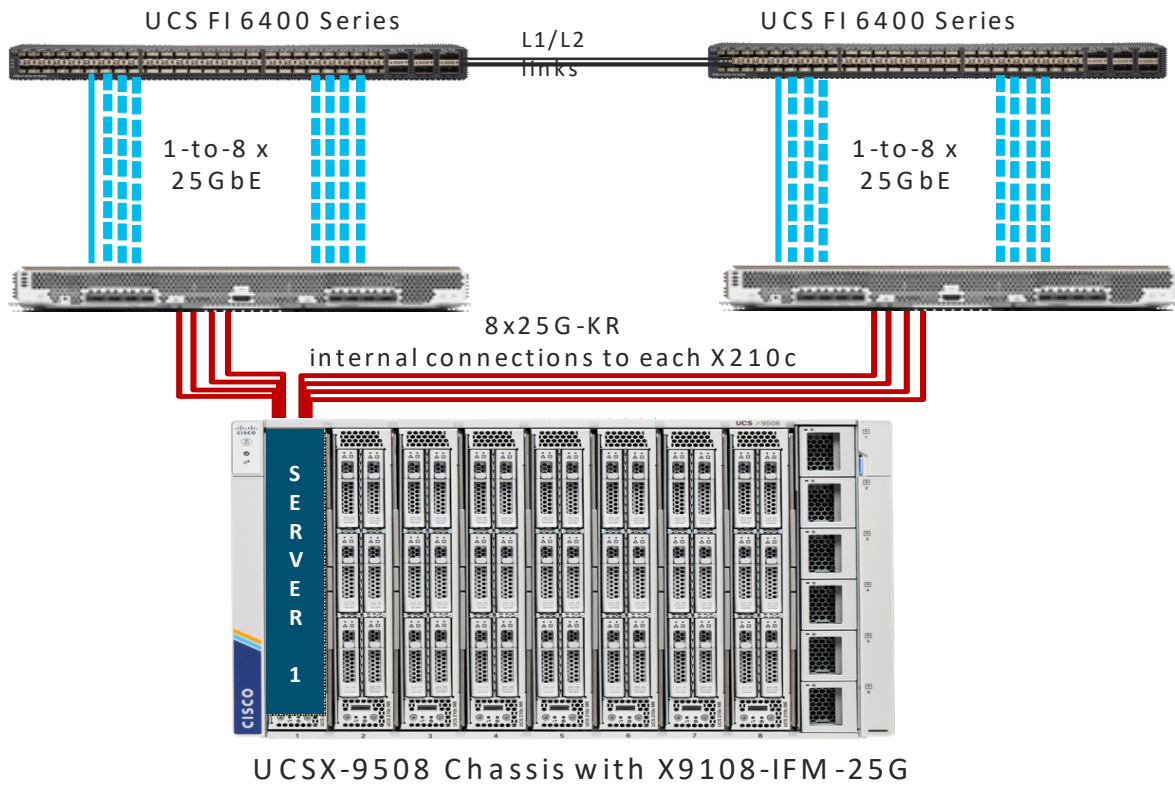

5108 Blade Chassis Server Connectivity

For the 5108 blade chassis, the Fabric Extender modules (up to two) plug into the back of the UCS 5108 series blade server chassis. A midplane connects the blade servers to the Fabric Extenders. The 5108 chassis accommodates the following FEXs:

- Cisco UCS 2208XP
- Cisco UCS 2204XP
- Cisco UCS 2408

Figure 18 shows how the FEX modules in the blade chassis connect to the FIs.

Figure 18 Connecting Blade Chassis Fabric Extenders to Fabric Interconnect Chassis

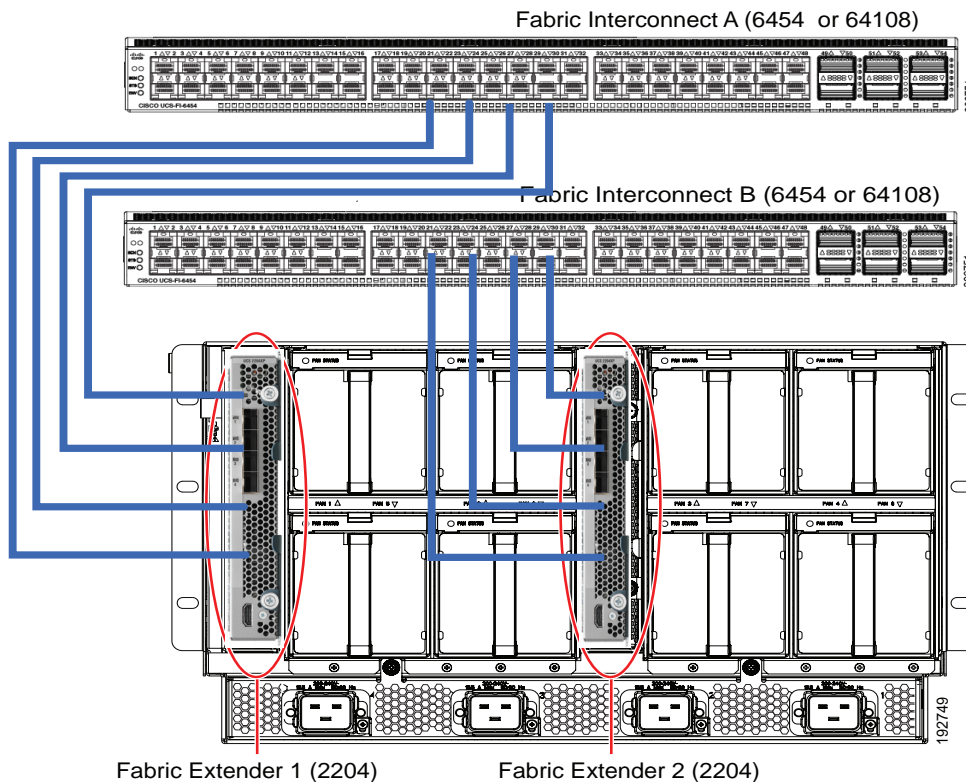

NOTE: Cisco UCS 5108 rev 1 and rev 2 chassis are both supported with FI 6454 and 64108.

C-Series Rack-Mounted Server Connectivity

C-Series servers connect to external FEXs and FIs as summarized in this section. Two interconnection methods are possible:

- Single-Wire Management
- Dual-Wire Management

Single-Wire Management

Cisco UCS Manager 3.1 supports an additional option to integrate the C-Series Rack-Mount Server with Cisco UCS Manager using the NCSI. This option enables Cisco UCS Manager to manage the C-Series Rack-Mount Servers using a single-wire for both management traffic and data traffic. When you use the single-wire management mode, one host facing port on the FEX is sufficient to manage one rack-mount server, instead of the two ports you would use in the Shared-LOM mode. This connection method allows you to connect more rack-mount servers with Cisco UCS Manager 3.1 for integrated server management. Make sure you have correct server firmware for integration with Cisco UCS Manager. If not, upgrade your server firmware before integrating the server with Cisco UCS Manager.

Figure 19 shows how the C-Series rack mount chassis connect to the FEXs and FIs for single-wire management.

Figure 19 Connecting C-Series Rack Chassis (single-wire management)

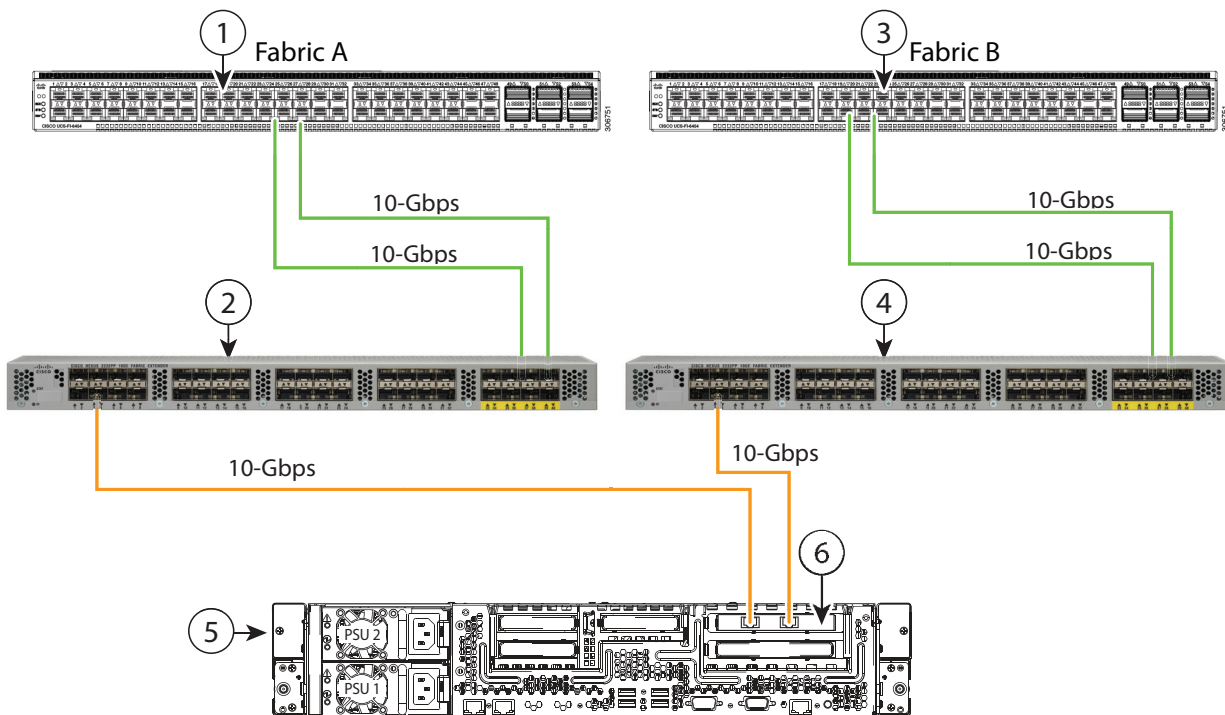

1	Cisco UCS 6454 or 64108 FI (Fabric A)	4	Cisco Nexus 2232PP or 2232TM-E (Fabric B)
2	Cisco Nexus 2232PP or 2232TM-E (Fabric A)	5	Cisco UCS C-series M5 server
3	Cisco UCS 6454 or 64108 FI (Fabric B)	6	Cisco UCS VIC 1445 in PCIe slot 1

Dual-Wire Management

Cisco UCS Manager version 3.1 supports the existing rack server integration and management option through Shared LOM, using two separate cables for data traffic and management traffic. The prerequisites for integration with Cisco UCS Manager are built into the C-Series servers. Make sure you have correct server firmware for integration with Cisco UCS Manager. If not, upgrade your server firmware before integrating the server with Cisco UCS Manager.

Figure 20 shows how the C-Series rack mount chassis connect to the FEXs and FIs for dual-wire management.

Figure 20 Connecting C-Series Rack Chassis (dual-wire management)

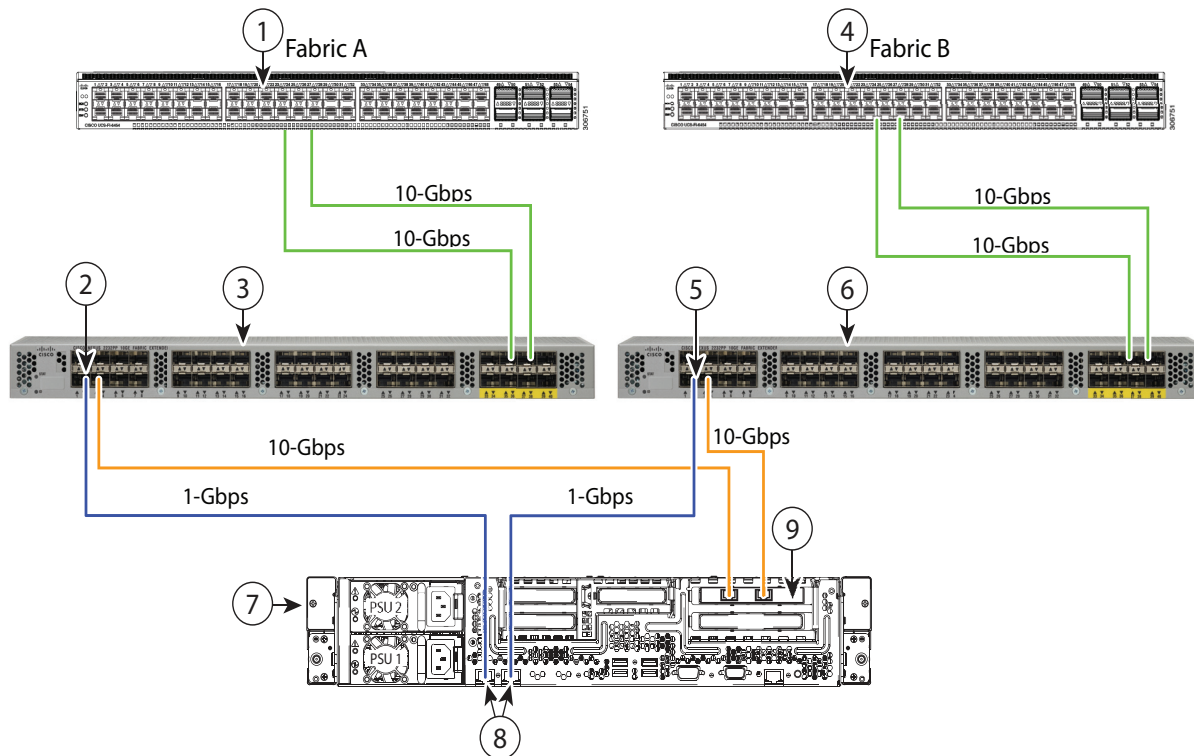

1	Cisco UCS FI 6454 or 64108 (Fabric A)	6	Cisco Nexus 2232PP (Fabric B)
2	10GBase-T RJ-45 in Nexus 2232PP (Fabric A)	7	Cisco UCS C-series M5 server
3	Cisco Nexus 2232PP (Fabric A)	8	10-Gbps Ethernet LOM ports
4	Cisco UCS FI 6454 or 64108 (Fabric B)	9	10-Gbps Adapter card in PCIe slot 1
5	10GBase-T RJ-45 in Nexus 2232PP (Fabric B)	—	—



NOTE: In addition to supporting single wire management and dual wire management, FI 6454 and 64108 also support direct connection to C-Series.

Blade Chassis Connection Types

In a blade chassis, the FEX fabric link (the link between the FEX and the FI) supports different types of connections:

- Port Channel Mode

In port channel mode, the FEX fabric links are bundled into a single logical link (see [Figure 21](#)) to provide higher bandwidth to the servers. Depending the FEX, up to 8 links can be port-channelled.

Figure 21 FEX Fabric Links in Port Channel Mode

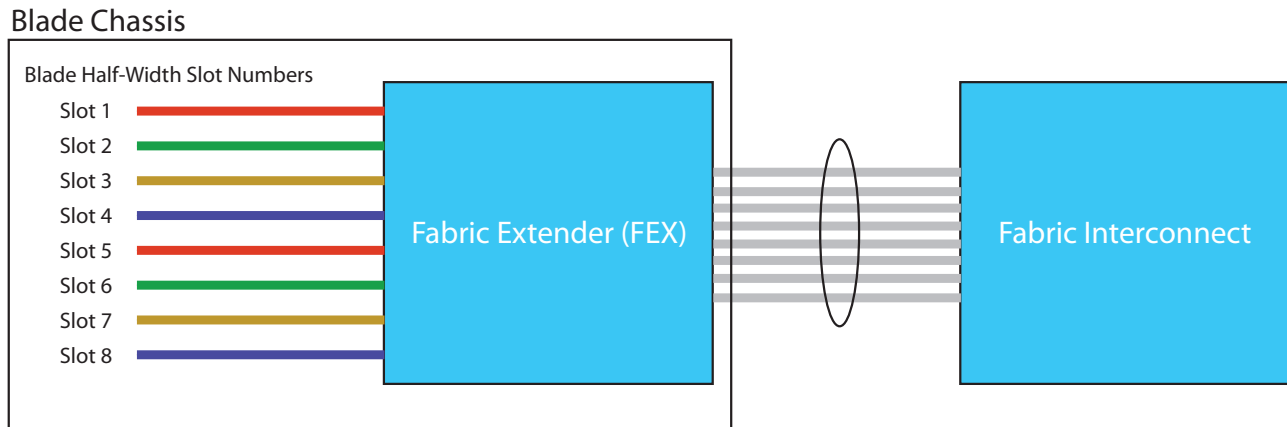

TECHNICAL SPECIFICATIONS

Physical and Environmental Specifications

Table 33 Physical and Environmental Specifications

Description	Specification
Cisco UCS 6454 FI	
Dimensions (H x W x D)	1.72 in. x 17.3 in x 22.5 in (4.4 cm x 43.9 cm x 57.1 cm)
Weight (with two power supplies and fans installed)	22.24 lb (10.10 kg)
Temperature, operating	32 to 104°F (0 to 40°C)
Temperature, non-operating	-40 to 158°F (-40 to 70°C)
Humidity (RH), non-condensing	5 to 95%
Altitude	0 to 13,123 ft (0 to 4000 m)
Cisco UCS 64108 FI	
Dimensions (H x W x D)	3.38 in. x 17.42 in x 22.95 in (8.33 cm x 44.25 cm x 58.29 cm)
Weight (with two power supplies and fans installed)	35.86 lb (16.27 kg)
Temperature, operating	32 to 104°F (0 to 40°C)
Temperature, non-operating	-40 to 158°F (-40 to 70°C)
Humidity (RH), non-condensing	5 to 95%
Altitude	0 to 13,123 ft (0 to 4000 m)

Power Supply Specifications

Table 34 Specifications for the Cisco UCS 6454 AC Power Supply (UCS-PSU-6332-AC)

AC Power Supply Properties	Description
Maximum AC input current	7.6 A @ 100 VAC 3.65 A @ 208 VAC
Maximum input VA	760 VA
Maximum output per power supply	650 W
Maximum inrush current	11 A peak at +35 degrees C @208 VAC
Maximum holdup time	12 ms @50% load
Power supply output voltage	12 VDC
Power supply standby voltage	12 VDC
Efficiency rating	Climate Savers Platinum Efficiency (80Plus Platinum Certified)
Form factor	1U
Input connector	IEC320 C14

Table 35 Specifications for the Cisco UCS 6454 DC Power Supply (UCS-PSU-6332-DC)

DC Power Supply Properties	Description
Maximum AC input current	23 A @ -48 VDC
Maximum input VA	1104 VA
Maximum output per power supply	930 W
Maximum inrush current	35 A Peak at +35 degree C
Maximum holdup time	8 ms @50% load
Power supply output voltage	12 VDC
Power supply standby voltage	12 VDC
Efficiency rating	Climate Savers Platinum Efficiency (80Plus Platinum Certified)
Form factor	1U
Input connector	Molex: 445401-1001

Table 36 Specifications for the Cisco UCS 64108 AC Power Supply (UCS-PSU-64108-AC)

AC Power Supply Properties	Description
Maximum AC input current	7A at 200 VAC
Maximum input VA	1400
Maximum output per power supply	1200 W
Maximum inrush current	30 A peak at 25 degrees C
Maximum holdup time	12 ms
Power supply output voltage	12 VDC
Power supply standby voltage	12 VDC
Efficiency rating	80PlusPlatinum
Form factor	RSPI
Input connector	IEC60320 C14 type connector

Table 37 Specifications for the Cisco UCS 64108 DC Power Supply (UCS-PSU-64108-DC)

DC Power Supply Properties	Description
Maximum DC input current	23 A maximum at -48 VDC
Maximum input VA	1104
Maximum output per power supply	930 W
Maximum inrush current	35 A peak at +35 degrees C, at -48Vdc
DC line dropout holdover storage	8 ms minimum at half of output load
Power supply output voltage	12 VDC
Power supply standby voltage	12 VDC
Efficiency rating	88% at 20% load, 92% at 50% load, 88% at 100% load
Form factor	RSPI
Input connector	Molex MINIFIT SR. R/A HDR. P/N: 44540-1001

For configuration-specific power specifications, use the Cisco UCS Power Calculator at:

<https://express.salire.com/Go/Cisco/Cisco-UCS-Power-Calculator.aspx>

Transceiver Specifications

For transceiver specifications, see the following link:

http://www.cisco.com/c/en/us/td/docs/interfaces_modules/transceiver_modules/compatibility/matrix/GE_Tx_Matrix.html



Americas Headquarters
Cisco Systems, Inc.
San Jose, CA

Asia Pacific Headquarters
Cisco Systems (USA) Pte. Ltd.
Singapore

Europe Headquarters
Cisco Systems International BV Amsterdam,
The Netherlands

Cisco has more than 200 offices worldwide. Addresses, phone numbers, and fax numbers are listed on the Cisco Website at www.cisco.com/go/offices.

Cisco and the Cisco Logo are trademarks of Cisco Systems, Inc. and/or its affiliates in the U.S. and other countries. A listing of Cisco's trademarks can be found at www.cisco.com/go/trademarks. Third party trademarks mentioned are the property of their respective owners. The use of the word partner does not imply a partnership relationship between Cisco and any other company. (1005R)

